

UBC780XLT

TRUNK TRACKER III



500-Channel Trunk Tracking Scanner

Uniden[®]
Operating Guide

Introduction

The UBC780XLT is a state-of-the-art radio with TrunkTracking™ and automatic scanning capabilities. It can store frequencies such as police, fire/emergency, marine, railroad, air, amateur, and other communications into 10 banks of 50 channels each.

Use your new scanner to monitor:

- Police and Fire Departments (including rescue and paramedics), and Ambulance Services
Private and Government Trunked Systems
- VHF High Band, UHF, 800MHz
- Trunking for Motorola, EDACS and LTR Systems
- Business/Industrial Radio
- Utilities
- Marine and Amateur (ham radio) Bands
- Air Band
- And much more...

The chart below identifies the scanner band numbers, the frequency range, the modulation mode and the default step size settings.

Band No.	Frequency Range (MHz)	Mode	Step (kHz)
1	25.0000–27.9950	AM	5
2	28.0000–69.9900	FM	10
3	70.0000–87.9875	FM	12.5
4	88.0000–107.9000	WFM	100
5	108.0000–136.9875	AM	12.5
6	137.0000–147.9950	FM	5
7	148.0000–173.9875	FM	12.5
8	174.0000–224.9950	WFM	100
9	225.0000–399.9500	AM	50
10	400.0000–512.0000	NFM	12.5
11	806.0000–956.0000	NFM	12.5
12	1240.0000–1300.0000	NFM	12.5

Important Notice

- Changes or modifications to this product not expressly approved by Uniden, or operation of this product in any way other than as detailed by this Operating Manual are violations that could void your authority to operate this product or claim warranty on this product.
- The screen displays used in this manual are representations only of what will appear when you use your scanner.
- This Owners Manual may include foreign terms not applicable to Australian version and conditions.

Front View and Display

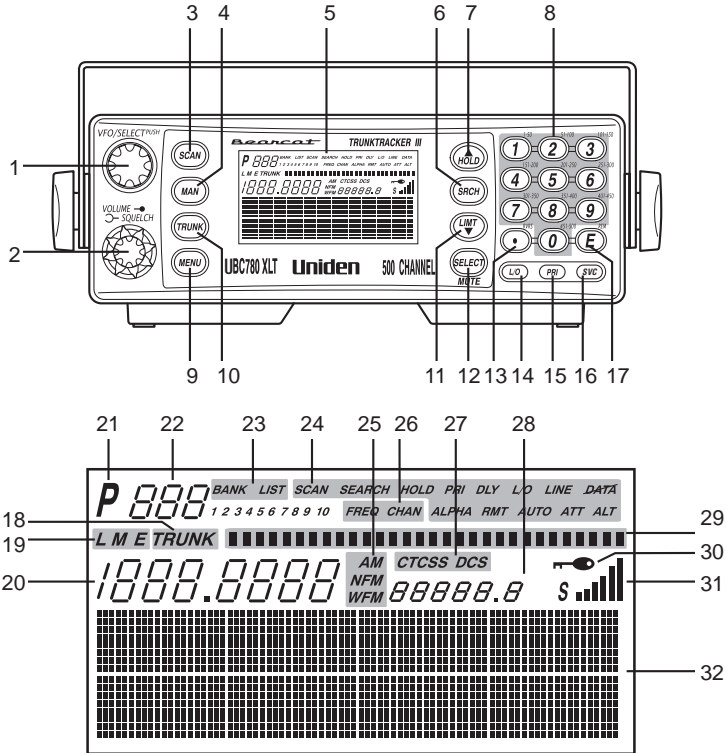

- | | |
|--|--|
| 1. VFO/SELECT Control | 17. Enter/Remote Key (E/REM) |
| 2. VOLUME/SQUELCH Control | 18. Trunk Mode Indicator |
| 3. Scan Key (SCAN) | 19. Trunk Type Indicators |
| 4. Manual Key (MAN) | 20. Frequency Display |
| 5. Display | 21. Priority Channel Indicator |
| 6. Search Key (SRCH) | 22. Channel Number Display |
| 7. Hold/Up Key (HOLD/▲) | 23. Bank/Trunk Scan List Indicator |
| 8. Numeric Keypad (each banks channel numbers) | 24. Scanner/Channel Mode Indicators |
| 9. Menu Key (MENU) | 25. Receiving Mode Indicators |
| 10. Trunk Key (TRUNK) | 26. Frequency/Channel Indicators |
| 11. Limit/Down Key (LIMIT/▼) | 27. CTCSS/DCS Indicators |
| 12. Select/Mute Key (SELECT/MUTE) | 28. ID/Code/Frequency Display |
| 13. Decimal/Reverse Key (○/RVRS) | 29. Trunk Repeater Activity Indicators |
| 14. Lockout Key (L/O) | 30. Enter Lock Indicator |
| 15. Priority Key (PRI) | 31. Signal Meter |
| 16. Service Key (SVC) | 32. Character Display |

Rear View

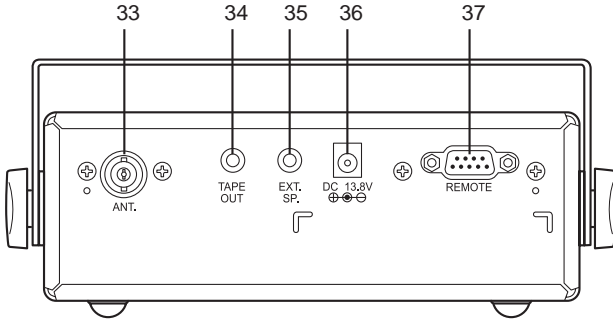

33. Antenna Connector

34. Tape Recorder Output Jack

35. External Speaker Jack

36. DC Power Jack

37. Remote Control Terminal

UBC780XLT Flow Charts

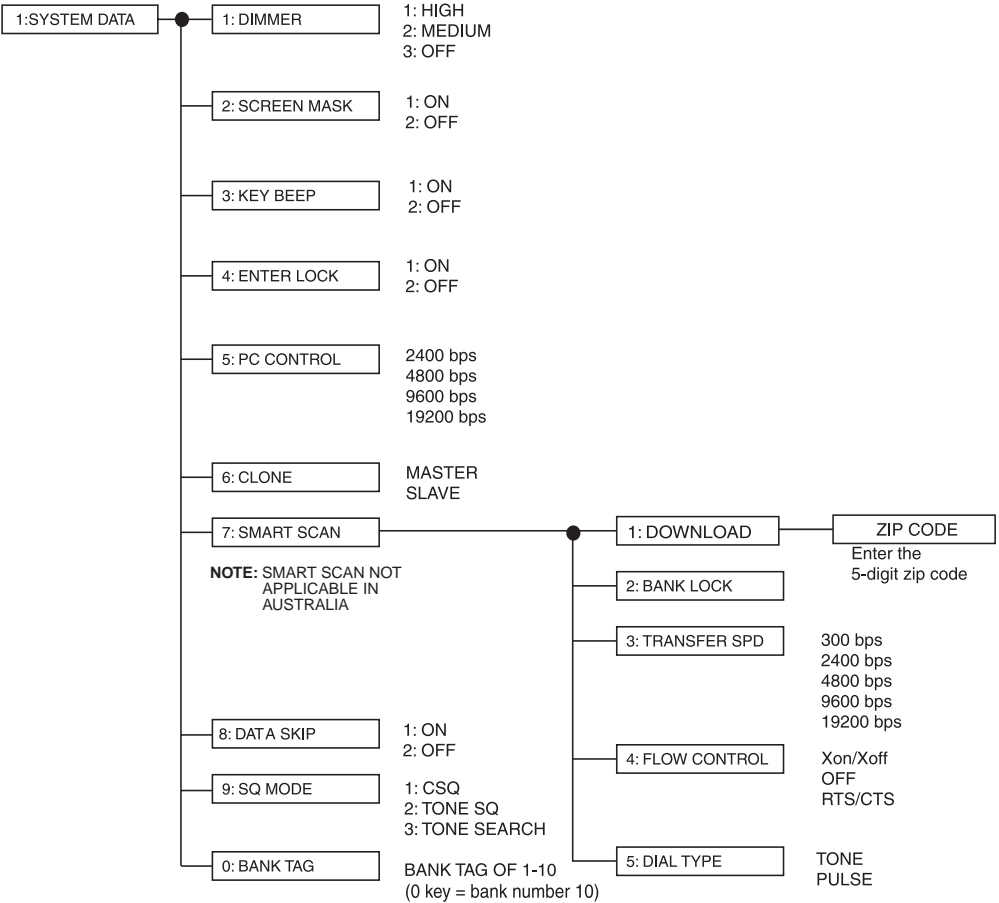

UBC780XLT Flow Charts (continued)

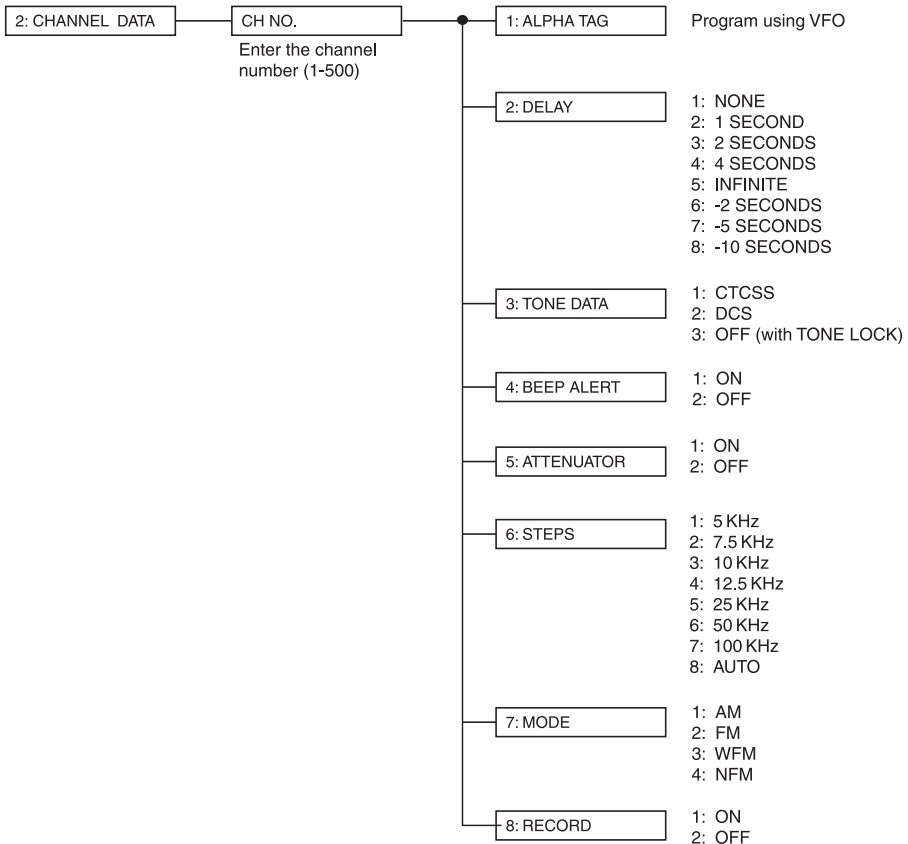

UBC780XLT Flow Charts (continued)

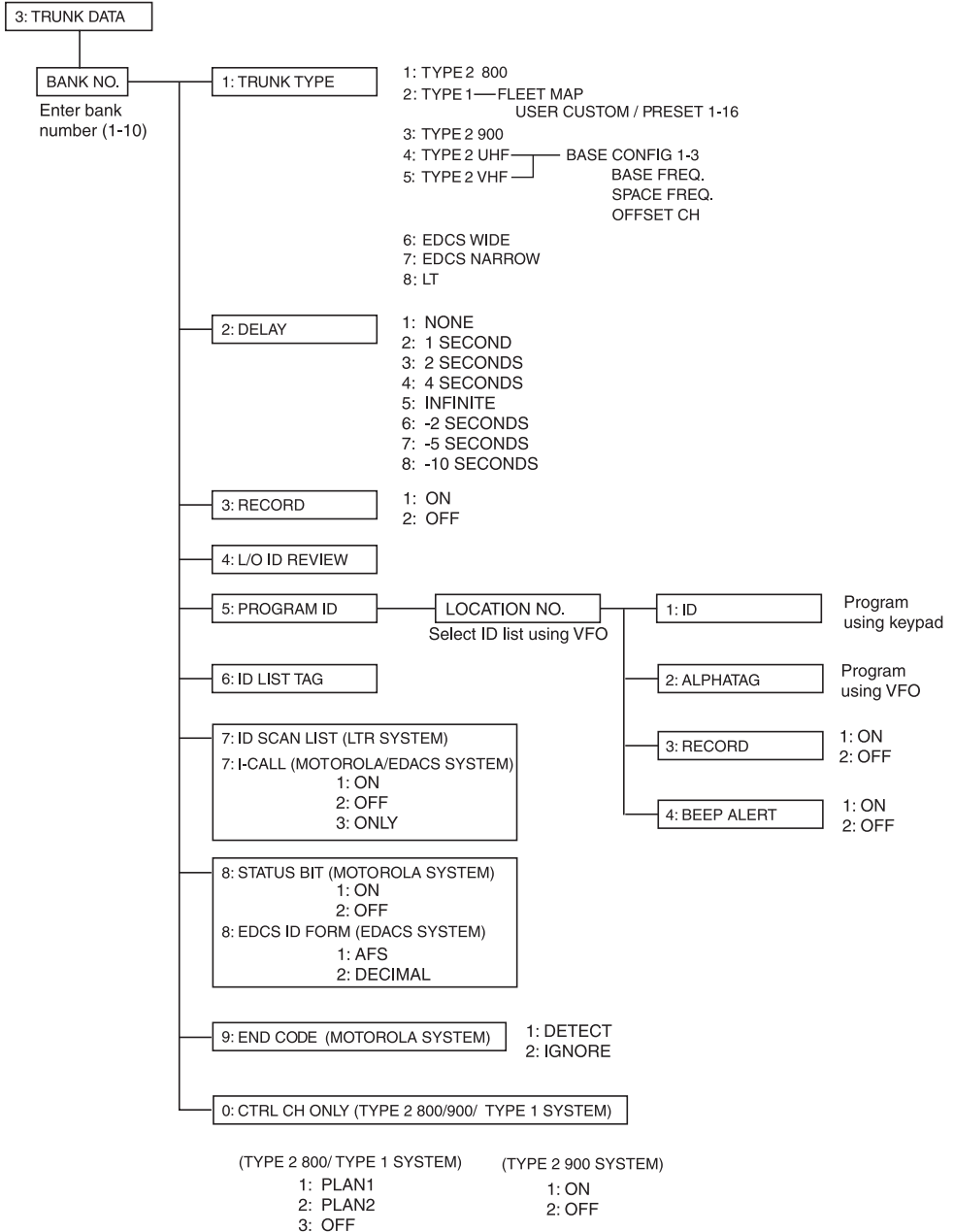

UBC780XLT Flow Charts (continued)

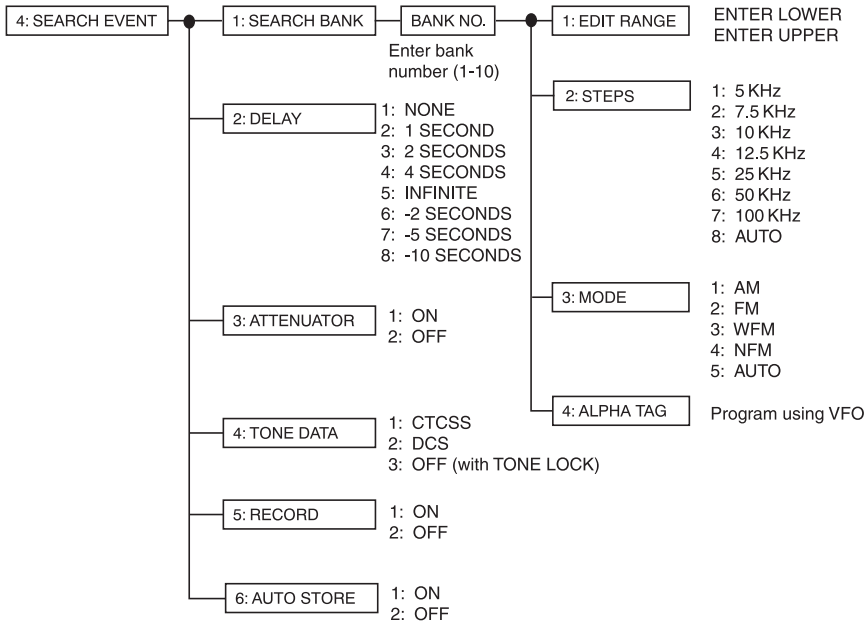

Contents

Introduction	inside front cover
Terminology	1
What is Scanning?	1
What is Searching?	1
What is Trunk Tracking?	1
Feature Highlights	3
Included with Your Scanner	4
Setup	5
Connecting an Antenna	5
Mounting an Antenna	5
Optional Antenna	5
Typical Mounting Methods	6
Mounting the Scanner in Your Vehicle	6
Applying Power for Vehicle Installation	7
Desktop Installation	8
Applying Power Using Standard AC Power	8
Connecting an External Speaker	8
Connecting an Earphone	9
Listening Safely	9
Connecting the Clone Cable	9
Connecting the Tape Recorder	9
Basic Operation	10
Turn the Scanner On	10
Setting the Squelch	10
Understanding the Menu System	11
Programming	18
Storing Frequencies into Channels	18
Duplicate Frequency Alert	19
Storing Text Tags	19
Beep Alert	20
Programming Tips	20
Deleting a Stored Frequency	20
Scanning	21
RF Attenuation Feature	22
Setting the Delay Mode	22
Channel Lockout	23
Restoring a Locked-out Channel	24
Restoring All Locked-out Channels	24
Priority Scan	24
Changing the Priority Channel	25
Searching	26
Setting a Search Range	26
Search Hold Feature	27
Data Skip	27
Frequency Skip	27
Storing Search Frequencies	28
Auto Storing	28
Squelch (SQ) Mode	29
Additional Menu Options for Searching	30
Service Search	31
Service Search Skip	31
Trunked Systems	32
Programming and Receiving Trunked Systems	33
Programming Trunking Frequencies	33

Selecting Trunking Programming Menu Mode	.34
Selecting Trunking System Type	.34
Setting the Squelch	.35
Receiving Trunked Systems	.35
Trunked Search	.35
ID Hold and Direct Entry ID Hold Mode	.36
ID Lockout	.36
Restoring Locked-out IDs	.37
Channel Activity Indicators	.37
Scan Lists	.38
Programming ID Scan Lists Manually	.38
ID Scan Mode	.40
Setting Priority in Trunking Mode	.41
Programming Scan Lists During Search	.41
Deleting a Stored ID	.41
Moving between Scan List Memories	.41
I-Call (Motorola/EDACS)	.42
Multi-Track	.43
EDACS Reception	.45
EDACS Tracking	.45
Programming System Frequencies	.45
An EDACS trunked System	.46
Special EDACS Features	.47
LTR Reception	.48
LTR Tracking	.48
Motorola Reception	.49
Motorola Tracking	.49
Fleet Map Programming	.50
Selecting a Preset Fleet Map	.50
Programming a Fleet Map	.50
Programming a Hybrid System	.51
Setting the Base, Spacing Frequencies and Offset Channel for Motorola VHF/UHF Trunked Systems	.51
Toggling the Status Bit	.52
Control Channel Only Mode	.53
Disconnect Tone Detect Option	.54
Remote Interface	.55
Remote (PC Control) Mode	.55
Clone Mode	.56
Additional Features	.58
Care and Maintenance	.60
Troubleshooting	.61
Specifications	.63
Glossary of Terms	.64
Appendix	.66
One Year Limited Warranty	.inside back cover

Terminology

What is Scanning?

Unlike standard AM or FM radio stations, most two-way communications do not transmit continuously. The UBC780XLT scans the channels you program until it finds an active frequency.

Scanning stops on an active frequency and remains on that channel as long as the transmission continues. When the transmission ends, the scanning cycle resumes until another transmission is received.

What is Searching?

The UBC780XLT can search each of its 24 bands to find active frequencies. This is different from scanning because you are searching for frequencies that have not been programmed into your scanner. The scanner automatically chooses between two speeds while searching. Turbo Search, can search the VHF FM bands at up to 300 channels per second.

What is Trunk Tracking?

Conventional scanning is a simple concept. You enter a radio frequency in your scanner's memory which is used by someone you want to monitor. For example, the police in your area may broadcast on 460.500 MHz, the fire department on 154.445 MHz, the highway department on 37.900 MHz, etc. So when your scanner stops on a frequency, you usually know who it is, and more importantly, you can stop on a channel and listen to an entire conversation. This type of scanning is easy and fun.

As the demand for public communications has increased, many public radio users don't have enough frequencies to meet their needs, and this has created a serious problem. Trunking radio systems solve this problem.

In a trunked radio system, which contains up to 28 different frequencies, radio users are divided into groups, often called talkgroups, and these talkgroups are assigned specific IDs. When someone in a talkgroup uses their radio, a brief burst of data is broadcasted before each transmission. The trunking system computer uses this data to temporarily assign each radio in a talkgroup to an available frequency. If the group using a frequency stops broadcasting or pauses between replies for a few seconds, they are removed from the frequency so another talkgroup can use it.

Sharing of the available public service frequencies, or trunking, allows cities, counties, or other agencies to accommodate hundreds of users with relatively few frequencies. Following a conversation on a trunked system using a scanner is difficult, if not impossible. Because when there's a short break during the conversation you're monitoring, it's possible that the talkgroup will be assigned to a completely different frequency in the trunked system. This type of scanning is difficult and frustrating.

TrunkTrack™ changes this! Not only does your new UBC780XLT scan channels like a conventional scanner, it actually follows the users of a trunked radio system. Once you know a talkgroups ID, you won't miss any of the action.

If you're a new scanner enthusiast, you may want to read the first part of this manual and use your scanner in conventional mode before you begin trunk tracking. Understanding scanning fundamentals and its terminology will make trunk tracking much easier. A glossary of other commonly used terms is provided in the back. (Refer to the "Glossary of Terms" section.) But if you're already an experienced scanner operator, you may want to skip to Trunked System on page 32.

Feature Highlights

- **Trunk Tracking** – Follows VHF High Band, UHF, 800MHz trunked public and government service systems just as if conventional two-way communications were used.
- **Multi-Track** – Track more than one trunking system at a time. Scan conventional and trunked systems at the same time.
- **500 Channels** – Program one frequency into each channel. You must have at least one channel programmed to use the Scan mode.
- **24 Bands, 10 Banks** – Includes 24 bands, with Aircraft and 800 MHz. 10 banks with 50 channels each are useful for storing similar frequencies to maintain faster scanning cycles or for storing all the frequencies of a trunked system.
- **25 MHz-1300 MHz** – Indicates the range of frequencies that can be searched within the bands of your scanner.
Note: The frequency coverage is not continuous and excludes the 512-806MHz band.
- **10 Priority Channels** – You can assign one priority channel in each bank. Assigning a priority channel allows you to keep track of activity on your most important channel(s) while monitoring other channels for transmissions. You can also assign trunking priority talkgroups.
- **Preprogrammed Service (SVC) Search** – Allows you to toggle through preprogrammed Police, UHF CB, railroad, aircraft, and marine frequencies.
- **Unique Data Skip** – Allows your scanner to skip unwanted data transmissions and reduces birdies.
- **Memory Backup** – If the battery completely discharges or if power is disconnected, the frequencies programmed in your scanner are retained in memory.
- **Manual Channel Access** – Go directly to any channel.
- **Attenuator** – Reduces the signal strength on a per frequency basis.
- **Turbo Search** – Increases the search speed to 300 steps per second. This applies only to transmission bands with 5 kHz steps.
- **Text Tags** – You can customise your scanner by storing text tags (up to 16 characters).
- **Auto Store** – The scanner automatically arranges a memory store for searched frequencies.
- **CTCSS/DCS** – The scanner can receive and search for subaudible tones.

Included with Your Scanner Package

If any of these items are missing or damaged, immediately contact your place of purchase.

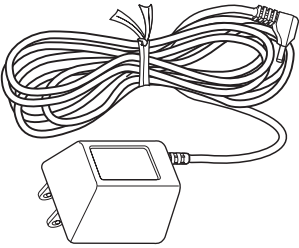

• AC Adaptor

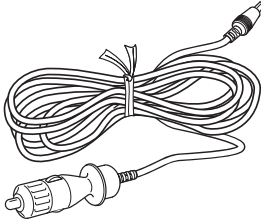

• Cigarette Lighter
Adaptor Cord

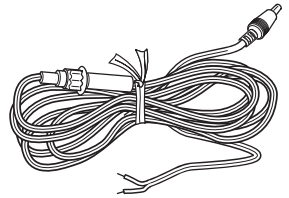

• DC Cord

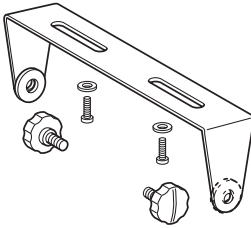

• Mounting Bracket

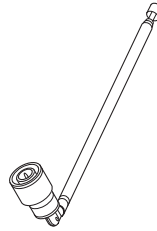

• Telescopic Antenna



• Operating Guide
• Other Printed Materials

Setup

Connecting an Antenna

You must install an antenna before you can operate the scanner. You have been provided a standard telescopic antenna that works well with this scanner, but you may want to purchase another type to increase the range. To connect the telescopic antenna, simply connect it to the BNC type **ANT.** connector on the rear of the scanner. You can purchase a variety of scanner antennas for both mobile and base station available at a local electronics store. Choose the one that best meets your needs.

When deciding on a mobile or base station antenna and its location, consider these points.

- The antenna should be as high as possible on a vehicle or a house.
- The antenna and its cable should be as far as possible from sources of electrical noise (ignition systems, gauges, and so on).
- The antenna should be vertical for the best performance.

Mounting an Antenna

Once you choose an antenna, follow the mounting instructions supplied with the antenna. Then route the antenna cable to the scanner.

The antenna connector on your scanner makes it easy to use the scanner with a variety of antennas, such as an external mobile antenna or an outdoor base station antenna.

Always use 50 ohm coaxial cable, such as RG-58 or RG-8, to connect an outdoor antenna. For lengths over 50 feet, use RG-8 low-loss dielectric coaxial cable. If your antenna's cable does not have a BNC connector, you will also need a BNC adaptor (available at a local electronics store).

Follow the Installation instructions supplied with the antenna, route the antenna cable to the scanner, then connect it to the **ANT.** jack.

Warning: Use extreme caution when you install or remove an outdoor antenna. If the antenna starts to fall, let it go! It could contact overhead power lines. If the antenna touches a power line, contact with the antenna, mast, cable, or guy wires can cause electrocution and death. Call the power company to remove the antenna. DO NOT attempt to do it yourself.

Optional Antenna

If you have chosen an optional mobile antenna, connect the antenna plug into the **ANT** connector on the rear of the scanner. (For more information on antenna installation, please refer to the instruction guide that came with your antenna.)

Typical Mounting Methods

The UBC780XLT can be conveniently mounted on a table, bulkhead, overhead, or any other desired location (refer to figure below for typical mounting methods).

Caution: Make sure there are no hidden electrical wires or other items behind the desired location before proceeding. Check that free access for mounting and cabling is available.

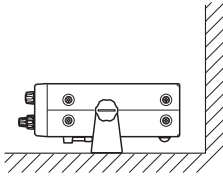

• Table top mount

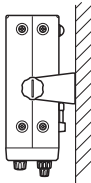

• Bulkhead mount

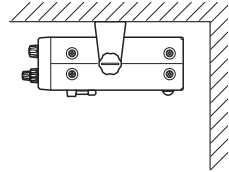

• Overhead mount

Mounting the Scanner in Your Vehicle

Before you mount the scanner, make sure you have all the necessary materials. Then confirm that the scanner fits your vehicle's mounting area. This unit requires a mounting area of 61mm high by 176.5mm wide by 167mm deep.

Caution: Be sure to avoid obstructions behind the mounting surface.

Follow these steps to mount the scanner in your vehicle.

1. Choose a mounting location, then use the supplied mounting bracket as a template to mark the positions for the mounting screw holes.
2. In the marked positions, drill holes slightly smaller than the supplied screws.
3. Attach the mounting bracket to the mounting location using the supplied screws and lock washers.
4. Attach the scanner to the mounting bracket using the supplied mounting knobs.
5. Connect the antenna's cable to the **ANT.** connector on the back of the scanner.

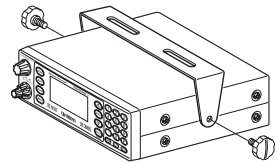
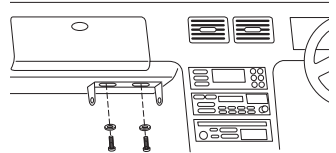

Note: If the antenna cable's connector does not fit in the **ANT.** connector, you might also need a Motorola-to-BNC antenna plug adaptor (available at a local electronics store).

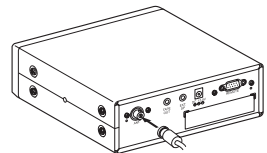

Applying Power for Vehicle Installation

You can power your scanner using either the supplied DC power cord or your vehicle's cigarette lighter socket using DC cigarette lighter power cord.

Caution: You must use a power source that supplies 13.8 V DC and delivers at least 700 mA. Your standard 12V car battery should be sufficient. The cord connector's centre tip must be set to positive and its plug must fit the scanner's **DC 13.8 V** jack. The supplied DC power cord meets these specifications. Using a power cord that does not meet these specifications could damage the scanner or the adaptor.

- Always connect the adaptor or DC power cord to the scanner before you connect it to the power source. When you finish, disconnect the adaptor or DC power cord from the power source before you disconnect it from the scanner.
- For added safety and to protect your scanner, disconnect the cable from your vehicle battery's negative (-) terminal before you begin.

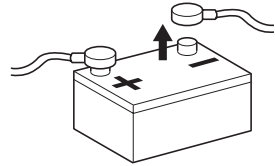

Follow these steps to connect the supplied DC power cord.

1. Connect the power cord's black wire to a chassis ground, such as a metal screw attached to a metal part of the vehicle's frame. Be sure that the screw is not insulated from the frame by a plastic part.
2. Connect the power cord's red wire (with in-line fuse) to a source of voltage that turns on and off with the ignition switch, such as a spare accessory terminal in your vehicle's fuse box.
3. Insert the power cord's barrel plug into the **DC 13.8 V** jack on the back of the scanner.
4. Reconnect the cable to the vehicle battery's negative (-) terminal.

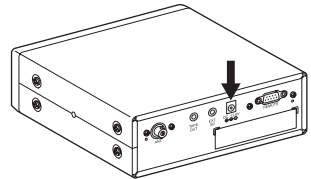
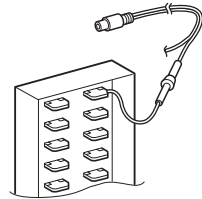

To power the scanner from a vehicle's 12 V power source (such as a cigarette-lighter socket), use the supplied cigarette-lighter adaptor cord.

To connect the supplied DC cigarette-lighter power cord, insert its barrel plug into the **DC 13.8 V** jack on the back of the scanner, then plug the power cord into your vehicle's cigarette lighter socket.

Note: If you use a cigarette-lighter power cord and your vehicle's engine is running, you might hear electrical noise from the engine while scanning. This is normal.

Desktop Installation

You can place this scanner on a desk, shelf, or table to use it as a base station.

1. Flip up the feet for desk installation.
2. Extend the antenna to full vertical position. Adjust the angle for best reception.

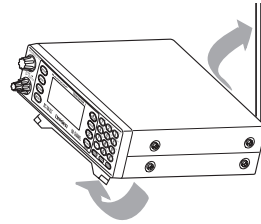

Applying Power Using Standard AC Power

To power the scanner from an AC outlet, use the provided AC adaptor with a 5.5 mm outer diameter/2.1mm inner diameter tip.

Caution: You must use only the AC adaptor provided as power source that supplies 13.8 V DC and delivers at least 700 mA. The cord connector's centre tip must be set to positive and its plug must fit the scanner's **DC 13.8 V** jack. Using an adaptor that does not meet these specifications could damage the scanner or the adaptor.

- Always connect the AC adaptor to the scanner before you connect it to AC power. When you finish, disconnect the adaptor from the AC power before you disconnect it from the scanner.

1. Insert the adaptor's barrel plug into the **DC 13.8 V** jack on the back of the scanner.
2. Plug the adaptor into a standard AC outlet.

Note: Use only the AC adaptor supplied with your scanner.

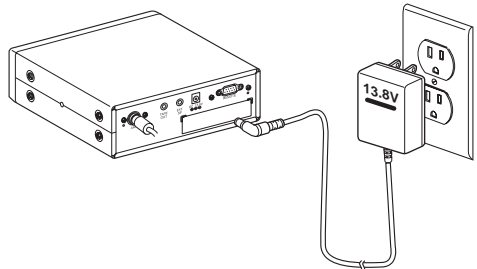

Connecting an External Speaker

In a noisy area, an external speaker (available at a local electronics store) positioned in the right place might provide more comfortable listening.

Plug the speaker cable's 1/8 inch (3.5 mm) plug into your scanner's **EXT. SP.** jack.

Note: Connecting an external speaker disconnects the scanner's internal speaker.

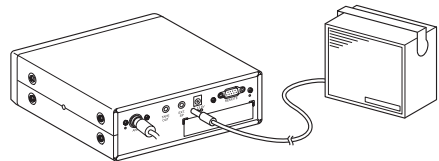

Connecting an Earphone

For private listening, you can connect an earphone (not supplied) with a 3.5 mm plug to the **EXT. SP.** jack on the back of the scanner. ***Be very careful as damage to your hearing can result if the VOLUME control is not set to the lowest level first.*** See below for “Listening Safely” instructions. (Your local electronics store should carry a wide selection of earphones.) Once the earphone is connected, it will automatically disconnects the internal speaker.

Listening Safely

To protect your hearing, follow these guidelines when you use an earphone or headphones.

- Do not listen at extremely high volume levels. Extended high volume listening can lead to permanent hearing loss.
- Set the **VOLUME** to the lowest setting before you begin listening. After you begin listening, adjust the **VOLUME** to a comfortable level.
- Once you set the **VOLUME**, do not increase it. Over time, your ears adapt to the volume level, so a volume level that does not cause discomfort might still damage your hearing.

Connecting the Clone Cable

You can transfer the programmed data to and from another UBC780XLT scanner using an RS232C Cable (9 pin to 9 pin) (not supplied). Connect the cable between each scanner's **REMOTE** jacks. See “Clone Mode” on page 56. You can also upload or download the programmed data to or from a PC using an optional PC interface kit available through your local electronics store.

Connecting the Tape Recorder

You can use a standard tape recorder or a VOX (Voice Operated Control) recorder. To connect the recorder to the scanner, connect a cable with a 1/8 inch (3.5 mm) plug from the tape recorder's remote jack to the **TAPE OUT** jack on the back of the scanner. (Your local electronics store should carry a wide selection of cables and tape recorders.) Refer to the “Record” section under “Additional Features” in the manual.

Remember!

- You must mark a channel, ID, talkgroup, or bank for Recording in order for this feature to work. The **LINE** icon appears on all channels that have been properly marked.
- This feature does not work if your scanner is set with **MUTE ON**.
- The **VOLUME** control affects the Audio output. Do not set the volume on minimum. Make a trial taping to be certain the volume levels are set correctly.

Basic Operation

Turn the Scanner On

Turn the **VOLUME** control clockwise out of the detent position. The scanner automatically starts scanning. Since there are no frequencies programmed in your scanner initially, you may not receive any signals. Once you set the squelch and program some frequencies, you will be hearing conversations regularly.

Setting the Squelch

To set the squelch, you must be in the Manual mode, and you should not be receiving a signal on your scanner.

1. Press **MAN** until you do not hear a signal.
2. Make sure that the **VOLUME** is set to a comfortable listening level.

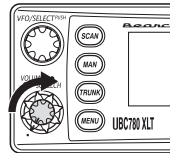

3. Think of the Squelch Control as a gate. Turn **SQUELCH** fully counter-clockwise. This raises the "Squelch Gate" so high that only very strong signals can get through.

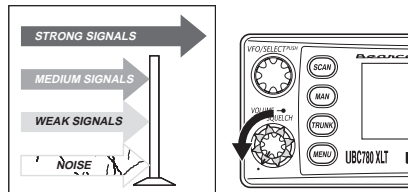

4. Turn **SQUELCH** fully clockwise until you hear a hiss. This lowers the "Squelch Gate" so that everything gets through – noise, weak signals, and strong signals.

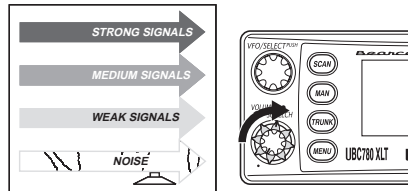

5. Turn **SQUELCH** back counter-clockwise just until the hiss stops. Now the "Squelch Gate" allows only clear signals through.

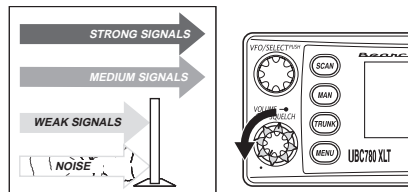

Next you must program some frequencies. (Page 18) It is recommended that you read the next part "Understanding the Menu System" because it will assist you in accessing and understanding many of the features. Later in a section called "Additional Features", you will find explanations on how to disable the keypad acknowledgement tones, how to mute the audio, how to change the appearance of the display and other general features.

Understanding the Menu System

It is very important for you to understand the Menu screen. To navigate through the Menu screen is really quite simple. Many of the features of this scanner, can only be accessed by the menu screens. There are several ways to get through the screens. First of all, press **MENU** to get started. Any time you want to exit this mode or simply quit from where you are, repeatedly press **MENU** until the scanner returns to the original state. Anytime you are in the Menu Mode, the audio will be muted.

To assist you in understanding the Menu screen, flow charts are provided towards the back of the manual so you can follow along. Two things to remember are *scroll* through the menu and *execute* the command. For simplicity, we have chosen to use the up and down arrow keys (▲ and ▼) in order to *scroll* through the menu and the **E** key for *entering* or *executing* a command. Once you have pressed the **E** key and executed the final choice (for instance, ON or OFF), the display backs up to the previous level of options.

Other methods for *scrolling* through the menu screen include rotating the **VFO** control or press and hold the up and down arrow keys (▲ and ▼) in order to *scroll* more quickly. Also direct entry of the numbers in the flow chart will get you through the screens, but the other screen options are not visible. This method should be used only after you have gone through the manual at least once. A tearout shortcut card is provided in the front of the manual to assist you in the direct entry method for commonly used features.

Another method for *entering* or *executing* the command, press the **SELECT/MUTE** key or press the **VFO/SELECT** control.

Below is the first level of the Menu screen. These levels are then expanded on the foldout towards the back of the manual. You will find a description section to explain the meanings of these functions on the next few pages. Then, you will be walked through all the steps of programming, scanning, searching, and trunktracking.

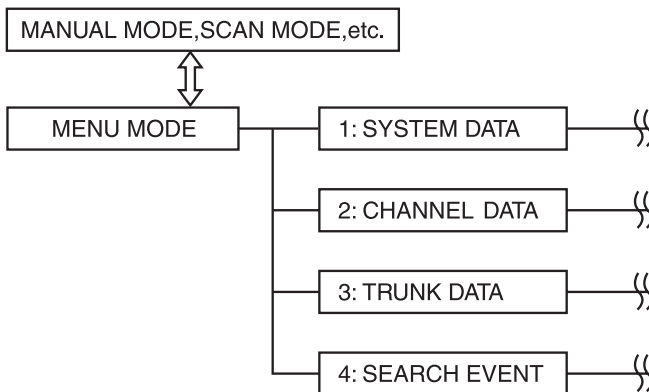

Menu Description and Numeric Keypad Equivalents

Below are the menu screens and a brief description or purpose of the feature.

1: SYSTEM DATA

1: DIMMER

Allows you to change the brightness of the display.

2: SCREEN MASK

Screen Mask allows you to limit what appears on the display to the alpha tags that you have set for a channel along with a few function icons. Screen Mask removes the frequency, receiving mode, tone data, signal strength bars, and the trunking repeater activity indicators. This mode is particularly useful in public safety vehicles where "information overload" is already a problem. Screen Mask does not work in Search mode.

3: KEY BEEP

Use this function to turn off the keypad acknowledgement beep. The default setting is on.

4: ENTER LOCK

Use Enter Lock to prevent accidental re-programming of channels and talkgroups entered into memory. The default setting is off.

5: PC CONTROL

Use this function to set the transfer speed (baud rate) at which your personal computer (PC) communicates with the scanner when downloading information into your scanner using the third party software. See page 55 for details.

6: CLONE

You can clone all the programming, including frequencies, talkgroups and alpha tags as well as bank settings and other parameters from one UBC780XLT to another.

7: SMART SCAN

Not applicable.

8: DATA SKIP

A scanner will normally stop on any transmission it receives. This means the UBC780XLT will occasionally stop on data signals and unmodulated transmissions. You can automatically skip many of these types of transmissions during search.

9: SQUELCH MODE

The Squelch Mode allows you to set, at your option, whether the scanner will stop on all active transmissions on a particular frequency or it will only respond to transmissions with a pre-set sub-audible tone. This applies to both conventional search and scan modes. The options are as follows:

1. CSQ - The default setting is CSQ (carrier squelch). In this mode the scanner will stop on any transmission on a programmed frequency (Squelch mode does not apply to trunking).
2. Tone SQ - In Tone Squelch mode, if you have set a subaudible tone (CTCSS or DCS) for a frequency, the scanner will only stop on that frequency if the transmission includes the prescribed tone.

3. Tone Search - In this mode, as soon as the scanner stops on any (non-trunked) channel, the scanner will begin to search for any subaudible tone that is being used on a transmitted frequency. The scanner will check each CTCSS tone sequentially and it will find DCS tones instantly.

0: BANK TAG

Allows you to set an alphanumeric text tag for individual banks in the scanner (1-10). (The "0" key represents Bank number 10.) For example, you may wish to set the Bank One text tag as Law Enforcement, the second bank as Fire, etc.

2: CHANNEL DATA

Choose the channel number. The following options are available for the selected channel only. Repeat using a different channel number, if necessary.

1: ALPHA TAG

Allows you to set an alphanumeric text tag for individual frequencies that you have programmed. For example, you can set CITY PD CH #3.

2: DELAY

The default delay for all programmed channels and talkgroups is two seconds. At the end of any transmission the scanner will remain on the frequency for two seconds before resuming scanning. This will allow you to catch most replies. You can change the delay to 1, or 4 seconds as well as set no delay (the scanner will immediately resume scanning after the end of a transmission). With the UBC780XLT you can also set negative or inverse delays, also known as Pause. With a 5 second pause, for example, the scanner will resume scanning after five seconds even if the transmission you are currently listening to has not ended. Finally, you can set an Infinite Delay. If a transmission is received on a frequency with Infinite delay set, the scanner will stop on the channel and remain on it until you have hit scan, search, etc.

3: TONE DATA

You can set a CTCSS (analog) or DCS (digital) sub-audible tone for a frequency. To do so you must have the Squelch Mode in the System Menu set to Tone Squelch. You can also program a subaudible tone easily by pressing the **E** (enter) key after programming a frequency. This will bring up the Tone Data menu without your having to navigate the Menu. You can also lock a tone assigned to a frequency. By doing this you will receive all transmissions on the frequency, regardless of the subaudible tone, except the one which you have locked. Any transmissions with that tone will not be received.

4: BEEP ALERT

You can set a Beep Alert on a per-channel basis to alert you when specific frequencies are active. For example, you may wish to be alerted anytime a mutual aid fire frequency is active. With beep alert, you will hear a rapid three-beep tone at the start of each transmission that you have flagged as such. You will also notice that as you scroll pass the flagged channel(s), you will hear the tones.

5: ATTENUATOR

The UBC780XLT comes with an RF Attenuation feature. If you are near an unusually strong signal source, the signal may overload the scanner. The scanner may stop repeatedly on that signal and miss other transmissions.

The RF Attenuation feature works in all modes and attenuates (reduces) the incoming signal strength to prevent stronger signals from overloading the scanner.

6: STEPS

Your UBC780XLT is programmed with default step sizes for each frequency range (see Introduction page). Steps are important if you are interested in using the VFO to tune off-frequency from a frequency programmed into memory or if you wish to program a frequency that the default step size will not accept.

7: MODE

Default receive modes are also programmed into memory. AM for the aircraft and CB bands, for example. All frequencies (other than TV broadcast audio) above 400 MHz are received in NFM mode which helps prevent adjacent channel interference. You can change the default settings on a per-channel basis with this Menu item.

8: RECORD

You can flag any channel for recording using this menu function. The **LINE** icon will become active for any such flagged channel. Use your own recording device plugged into the jack on the back of the scanner.

3: TRUNK DATA

Choose the Trunk bank. The following options are available for the selected trunk bank only. Repeat using a different trunk bank, if necessary.

1: TRUNK TYPE

You will need to assign the correct trunking type for the bank you are about to program. If you want to listen to a Motorola Type 1 system, you will need to use this menu option to assign the same.

Note: Some trunking systems require that you know the channel order. In these cases you will also need to start programming the trunked system at the start of the bank. The scanner defaults to the most common type of trunking system, Motorola Type II.

2: DELAY

You can set delay for a trunk system on a bank by bank basis. If you've set delay for 1 second, then there will be a one second delay in Trunk Search for that bank and a one second delay for all the talkgroups you have programmed into Scan List memory. You cannot set delay individually by talkgroup. The default delay is two seconds.

3: RECORD

This Record option applies to Trunk Search. If you have set Record on, the **LINE** icon will be lit. All talkgroups received during Trunk Search will be recordable through the **TAPE OUT** jack on the back of the scanner. To record individual talkgroups during Scan, see Item 5 on the next page. The default is off.

4: L/O ID REVIEW

Use this menu item to review the IDs that you have locked out during Search and Scan. Use the Up/Down arrow keys or turn the **VFO** to the left or right to view the IDs that have been locked out. To leave the lockout IDs unchanged, press **MENU** to back out of the menu. To unlock an ID, press the **L/O** key. To unlock all the IDs that have been locked out, press the **E** (Enter) key.

5: PROGRAM ID

You can program IDs into Scan List memory either during Trunk Scan or Search without going into the Menu. However, you can also use the Menu to program IDs. This is particularly helpful when you are not near the trunked system you wish to later monitor. You can set it up and have it ready to go at some later time.

After you have selected the Scan List location (1-10) and the memory location (1-10), you can then do the following:

- 1 Program the talkgroup or I-CALL ID number
- 2 Set an alpha tag for same
- 3 Assign the Record option for same. Whenever a transmission is active on the ID the signal can be recorded to a tape recorder using the **TAPE OUT** jack on the back of the radio.
4. Assign a Beep Alert to the ID. Whenever that ID is active, you will hear a rapid three beep tone at the start of the transmission.

6: ID LIST TAG

Assign an alphanumeric tag to any or all of the 10 Scan Lists for the system.

During Scan Mode, you will see the List Tag (on the bottom text line) along with any alpha tag you may have set for an ID. In Search mode, you will see any Bank Tag you have set.

7: I-CALL (MOTOROLA AND EDCS)

Most communications within a trunked system are group calls where one unit (such as a dispatcher) communicates with all the units within his/her group (all the patrol vehicles on the east side of town, for example). The units within this group comprise what is typically known as a talkgroup. There are some communications which are direct unit-to-unit conversations where one individual converses with another individual. The call is initiated by a radio and is directed to another single radio. Within the system, no one outside of these two users hears the conversation. Your UBC780XLT defaults to I-CALL OFF mode. You can hear these conversations by using this Menu item to turn the I-CALL function to ON. In Search mode, with I-CALL on, you will hear both talkgroup calls and I-CALLS. You can also set I-CALLS to I-CALL ONLY during which you will monitor only I-CALLS in Search mode. You can also program I-CALL IDs into Scan List memory.

OR

8: ID SCAN LIST (LT)

When scanning an LT system you can only turn Scan Lists off and on when an LT talkgroup that you have entered into memory is active. To provide you with another method to turn Scan Lists on and off, you can use this Menu item which only appears when you have selected LT in Trunk Type.

9: STATUS BIT (MOTOROLA)

On Type II trunking systems there is a method by which specialised types of communications utilise unique talkgroup numbers. An emergency call will occur on a unique talkgroup from its primary assignment, for example. Because the UBC780XLT defaults to Status-Bit On mode, you never need to worry about missing these transmissions. If you've programmed talkgroup 33264 into Scan List memory, for example, and there is an emergency call within the group, you will hear it on 33264.

OR

10:EDACS ID FORM (EDCS)

You can change to display the talkgroups in decimal mode, but this mode does not provide you with nearly the flexibility that you get with AFS. The UBC780XLT defaults to show the talkgroup number in AFS mode (Agency-Fleet-Subfleet). For details on AFS see pages 46.

11:END CODE (MOTOROLA)

When this function is disabled, the radio looks for squelch before returning to the control channel instead of waiting for the disconnect tone. Only in rare instances will you need to adjust the default settings.

The condition to return to control channels depends on whether signal is present or not.

12:CONTROL CH ONLY (MOTOROLA 800 & 900 SYSTEMS)

With this mode you will be able to track Motorola Type I and II 800 and 900 MHz trunked systems by simply entering the control channel which manages the trunked system. You will not have to program the voice channels. There are 4 channel plans which you can select from.

4:SEARCH EVENT

You can program up to 10 search ranges (one per bank). The first time you program a range for a bank you will need to do so through the Menu. After the first time you can program a range as you do on most any other scanner, using the numeric keypad and the ▲/**HOLD** or ▼/**LIMIT** keys.

1:SEARCH BANK

Use this Menu item to select the search bank that you want to program. You can program banks 1 through 10, one at a time. For each of the banks, the following options can be modified.

1:EDIT RANGE

Enter the upper and lower frequency limits of the search range.

2:STEPS

You can assign a variety of step sizes to the search range. **Note:** The default step is usually acceptable and is listed in the front of the manual. (See inside front cover)

3:MODE

You can change the default receive mode with this menu item.

4:ALPHA TAG

You can alpha tag any or all of the search banks.

2:DELAY

Set a delay for the search ranges. This applies to all ranges (See CHANNEL DATA-STEPS for details).

3:ATTENUATOR

Set attenuation for all search ranges. (See CHANNEL DATA-ATTENUATOR for details).

4:TONE DATA

The default mode is off. This means that you will receive all transmissions on any frequencies that are active within your search range(s). By selecting CTCSS or DCS you can set the radio to receive only a particular subaudible tone to be

received during your search. You can also lockout a particular CTCSS or DCS tone. You may wish to do this if you want to search a range but not hear transmissions on any frequency that have particular subaudible tone.

Note: Through the System Menu you can set the radio to operate in Tone Search mode during Search as well. In this mode, the radio will automatically determine the active subaudible tone on any frequency received during the Search.

5: RECORD

With Record set to on, any frequency that is active, during the search, can be recorded to an external tape recorder.

6: AUTO STORE

You can automatically store active frequencies found during a search into memory. You can select which bank you want to program the found frequencies. Note that the audio will be muted during Auto Store.

Programming

Before the UBC780XLT can begin conventional scanning, you must program a frequency into at least one channel. Repeat this procedure for each channel you want to program.

Storing Frequencies into Channels

1. Select desired frequency.
Here is a list of sample frequencies you can try:

156.800 Marine Calling channel
468.400 Police Channel
476.425 UHF CB

2. Press **MAN**.
3. Select a channel.

- a. Enter the channel number.
- b. Then press **MAN**.

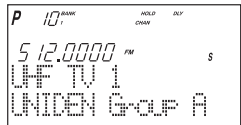
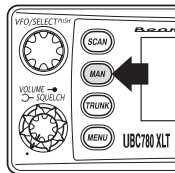

4. Enter the frequency.
 - a. Enter the frequency number.
 - b. Then press **E**.

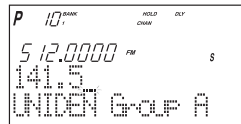
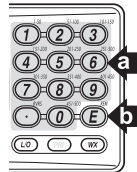

Note: • To clear a mistake while entering the frequency, press \odot (decimal key) repeatedly until the display is cleared.

- If you enter a channel or frequency which is out of the scanner's range, a distinctive beep will sound and **ERROR** appears in the display.

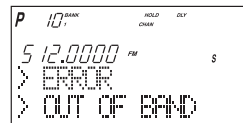

- You can use \blacktriangle or \blacktriangledown when selecting a channel. Press and hold \blacktriangle or \blacktriangledown for 1 second to move up/down more quickly.

Duplicate Frequency Alert

If you enter a frequency which has been stored in another channel, you will hear a beep and the other channel displays **WARNING**.

Press **⏪** to clear and start again.

— OR —

Press **E** again to store the frequency in both channels.

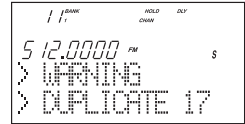

Storing Text Tags

You can customise your scanner by storing text tags for easy identification of banks, channel transmissions, trunking talkgroup IDs, etc. The text tags can be set at the menu mode. (Refer to Understanding Menu System on page 11.)

Assigning a Bank Tag to a Bank

1. Press **MENU**.
2. Press **E** to select **SYSTEM DATA**.
3. Press **▲** or **▼** to select **BANK TAG** and then press **E**.
4. Select the bank number to be tagged using **▲** or **▼** and then press **E**.
5. The cursor appears on the display. Rotate **VFO** to change letters, and then press **▲** or **▼** to shift right or left. Both capital and lower case letters are available, as well as numbers and punctuation marks.
6. After entering the desired text, press **E** or **SELECT**.

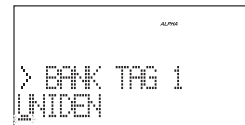
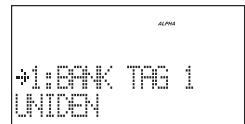

 **Remember!** You can also use the **VFO** control for scrolling. To clear a mistake while entering the frequency, press **⏪** (decimal key) repeatedly until the display is cleared.

Assigning a Text Tag to a Channel

1. Press **MENU**.
2. Press **▲** or **▼** to select **CH DATA** and then press **E**.
3. Select the channel number to be tagged using **▲** or **▼** and pressing **E**. You can also enter the channel number in using the keypad and then press **E**.
4. Press **▲** or **▼** to select **ALPHA TAG** and then pressing **E**.

Note: • If you have not stored a frequency in the channel, **UNREGISTERED** will appear in the display.

5. The cursor appears on the display. Rotate **VFO** to change letters, and press **▲** or **▼** to shift right or left. Both capital and lower case letters are available, as well as numbers and punctuation marks.
6. After entering the desired text, press **E**, **SELECT** or **VFO**.



Beep Alert

The scanner can alert you with three rapid beeps at the beginning of a transmission on an assigned frequency.

Assigning the beep alert to a channel

This alert can be set on/off to every channel (or to every ID memory for Trunking mode).

1. Press **MENU**.
2. Press **▲** or **▼** to select **CH DATA** and then press **E**.
3. Select the channel number to be tagged using **▲** or **▼** and then press **E**. (You can also enter the channel number in using the keypad or **VFO** control and then press **E**.)
4. Press **▲** or **▼** to select **BEEP ALERT** and then press **E**.
5. Press **▲** or **▼** to select **ON** or **OFF** and then pressing **E**.

Note: If **NOT REGISTER** appears, make sure a frequency is stored in the channel.

Programming Tips

- Group similar services into a bank. For example, program police frequencies in channels 1 through 10 and fire/emergency into channels 51 through 60, and so on.
- Put the frequency that you listen to the most or the most important frequency into a Priority channel.
- To quickly program a series of channels, start with the lowest number channel. For example, when you are programming five new frequencies into Channels 4 through 8, start with Channel 4. After you finish programming a channel, press **MAN** or **HOLD/▲** to go to the next higher channel.
- Write down your programmed channels and frequencies and put in a convenient place in case of accidental reprogramming.
- Frequencies are rounded off according to the step of each channel.
- When you are overwriting a tagged channel with a new frequency, the previous alpha tag will be deleted. You must re-enter the alpha tag.
- When programming frequencies, a 2 second delay is set automatically but can be changed in the Channel Data menu.

Deleting a Stored Frequency

To delete a stored frequency:

- a. Select a channel.
- b. Press **0**.
- c. Then press **E**.

Note: Channels with no frequencies are automatically locked out.

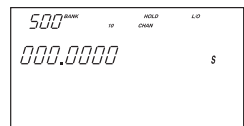

Scanning

1. After programming frequencies, simply press **SCAN** to begin scanning.



2. The bank indicators selected for scanning appear in the display, and the bank being currently monitored flashes. You can deselect banks from active scanning by pressing their number on your keypad. The indicator for each deselected bank turns off, and the banks channels are not scanned.

Note: One Bank must always be active. You cannot deactivate all ten banks at the same time. If you try to turn off all the banks, the first bank is automatically selected.

To restore a bank to active scanning, press the banks number on your keypad. The banks indicator will display again.

3. During normal scanning the scanner skips unprogrammed or locked out channels.
4. When a transmission is received, the scanner stops on that channel. When the transmission ends, scanning resumes automatically.

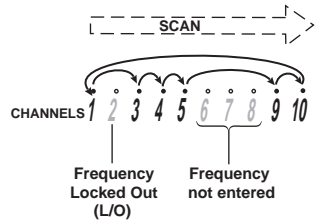

If you want to stop on a channel during scanning, press **MAN**.

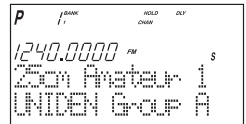

If you want to resume scanning, press **SCAN**.

To directly access a specific channel:

There are several ways to access a specific channel quickly.

1. Press **MAN**.
2. Using the keypad, enter the channel number.
3. Press **MAN** again.

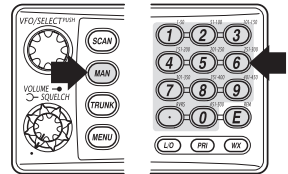

Another method is as follows:

1. Press the **VFO** control until **CHAN** is displayed.
2. Rotate the **VFO** control until the desired channel is displayed. The scanner will automatically go to manual mode.

Note: You can accidentally change the frequency if you don't verify that **CHAN** is displayed. If **FREQ** is displayed, you will be changing the frequency when you rotate the **VFO** control. Just don't press **E** or it will be changed!

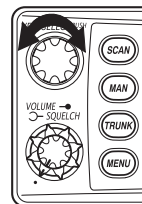

Still another method of direct access to a specific channel:

- 1 Press **MAN**.
- 2 Press **▲** or **▼** to select the channel. (or press and hold **▲** or **▼** to scroll more quickly.)

Lastly to step up through the channels one at a time, repeatedly press **MAN**.

RF Attenuation Feature

The UBC780XLT comes with an RF Attenuation feature. If you're near an unusually strong signal source, the signal may overload the scanner. The scanner may stop repeatedly on that signal and miss other transmissions.

The RF Attenuation feature works in all modes and attenuates (reduces) the incoming signal strength to prevent stronger signals from overloading the scanner.

The RF attenuation is set at the menu mode.

1. Press **MENU**.
2. For Search mode, press **▲** or **▼** to select **SEARCH EVENT** and then press **E**.
OR

For Scan mode, press **▲** or **▼** to select **CH DATA** and then press **E**. Then you must enter your channel data by pressing **▲**, **▼** or direct keypad entry. Then press **E**.

3. Press **▲** or **▼** to select **ATTENUATOR** and then press **E**.
4. Set to **ON** using **▲** or **▼** and then press **E**.
ATT appears on the display.

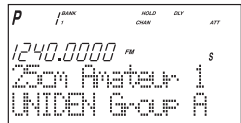

 **Remember!** You can also use the **VFO** control for scrolling. Also instead of pressing **E**, you can press the **VFO/SELECT** control or press the **SELECT/MUTE** key.

Note: Attenuation will only be active for the specified channel. In **SEARCH** mode, it is applied to the search ranges in all banks.

Setting the Delay Mode

A default delay of 2 seconds is automatically set for each frequency or talkgroup. A different delay can be set for each programmed channel so that when scan or search stops on a channel there is a brief pause before the scanning cycle resumes. To set the delay feature, enter into the menu mode.

1. Press **MENU**.
2. Press **▲** or **▼** to select **CH DATA** and then press **E**.
3. Select the channel number to be delayed using **▲** or **▼** and then press **E**.
4. Press **▲** or **▼** to select **DELAY** and then press **E**.

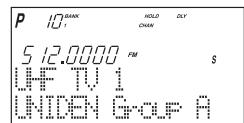

- Press ▲ or ▼ to select one of the delay periods provided and then press **E. DLY** appears on the display unless no delay has been set.
- For Search mode, select **SEARCH EVENT - DELAY**, then set the delay period.

Note: The delay periods are as follows:

- None: Delay feature off
- 1 sec.: Delays for 1 sec. before re-scanning
- 2 sec.: Delays for 2 sec. before re-scanning
- 4 sec.: Delays for 4 sec. before re-scanning
- Infinite: Stays on until SCAN is pressed
- -2 sec.: Stays for 2 sec. only before re-scanning *
- -5 sec.: Stays for 5 sec. only before re-scanning *
- -10 sec.: Stays for 10 sec. only before re-scanning *

*Setting negative delay periods are useful if you are only interested in small segments of conversations. For example: If you set a -5 second delay, you will only hear 5 seconds of the conversation and then the scanner will resume scanning, whether or not the conversation is finished.

Channel Lockout

You can lockout any channel so it is not checked during normal scanning. You can restore the channel to scanning when you wish.

Lockout in Manual Mode

- Press **MAN**.
- Select a channel.
Enter the channel numbers.
Press **MAN** again.

— OR —

Press **MAN** or **HOLD/▲** to change higher,
or **LIMIT/▼** to lower the channel.

- Press **L/O** to lockout the channel.
L/O appears in the display.

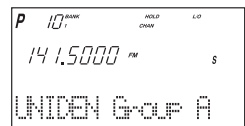
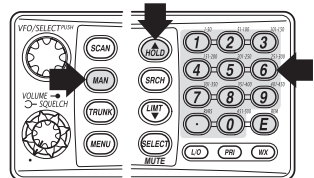

Lockout in Scanning Mode

If the scanner keeps stopping on a particular channel due to noise or too frequent transmissions, you may want to keep that channel from scanning.

- Wait until the scanner stops at the channel.
- Then press **L/O**.

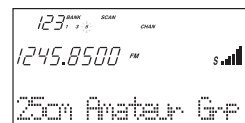

- The scanner immediately resumes scanning because the locked out channel is no longer in the scanning sequence.

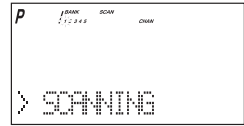

- Lockout Tips
- Write down your locked-out channels and put in a convenient place in case you need to restore them.

Restoring a Locked-out Channel

- Press **MAN**.
- Select a locked out channel.
 - Enter the channel number.
 - Then press **MAN** again.
- Press **L/O** to unlock the channel. The L/O icon goes out.

Restoring All Locked-out Channels

You can restore all locked-out channels in a bank only when a bank is selected for scan. If you have deselected a bank and you want to restore all of its locked-out channels using the steps below, you must press **SCAN** and then press the number of the bank on your keypad.

- Press **MAN**.

Note: You must be in Manual mode before restoring all locked-out channels.

- Press and hold **L/O** for about two seconds.
You will hear two beeps when all the channels have been restored.

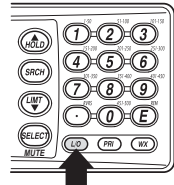

Priority Scan

When Priority Scan is turned on, your scanner checks the priority channel every two seconds for activity. If a signal is present on the priority channel, your scanner monitors the channel until the transmission ends, then resumes normal scanning. You can designate one channel in each bank as a Priority Channel. By default, the first channel in each bank is the priority channel, but you can change this.

To activate Priority Scan (in either the Manual or Scan Mode):

- Press **PRI**.

Note: If you have locked out the priority channel, **ERROR** message appears when you select Priority mode.

- Press **PRI** again at anytime to deactivate Priority Scan.

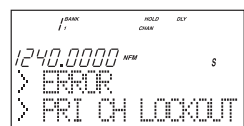
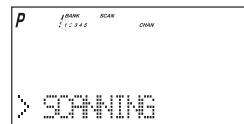

Changing the Priority Channel

You cannot eliminate the Priority Channel, but you can change it to any one of the 50 available channels in each bank.

1. Press **MAN**.

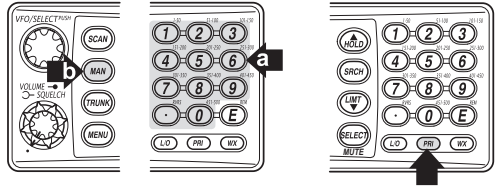

2. To select a new Priority Channel:

- Enter the channel number.
- Then press **MAN** again.

3. Press and hold **PRI** for two seconds to designate this channel as your new Priority Channel.

Two beeps indicate that the Priority channel has been changed. The **P** icon appears in the display.

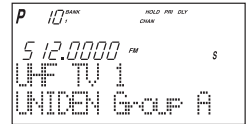

- Note:**
- Priority in Trunking mode works just the same, except instead of setting priorities for channels, you set them for talkgroup IDs. The scanner only checks priority talkgroups between transmission, not in 2 second intervals.
 - Priority scan is disabled while the **TRUNK** icon is lit (an error tone will sound if you try). To make it possible, turn off the **TRUNK** icon then press **PRI**.
 - At Priority scan, it scans the designated Priority Channels in the banks you selected.

Searching

Setting a Search Range

Note: First you must set the search ranges through the menu screen prior to any searching. The UBC780XLT can search up to 10 separate frequency ranges to help you discover new stations in your area.

To set a search range, enter into the menu mode.

1. Press **MENU**.
2. Press **▲** or **▼** to select **SEARCH EVENT** and then press **E**.
3. Press **▲** or **▼** to select **SEARCH BANK** and then press **E**.
4. Press **▲** or **▼** to select the desired bank number and then press **E**.
5. Press **▲** or **▼** to select **EDIT RANGE** and then press **E**.
6. Enter the lowest frequency using the keypad and then press **E**, then repeat the same for the highest frequency.
Then press **SRCH**.



- Note:**
- The scanner can search up to 10 ranges by selecting specific banks which you have programmed search ranges. (Chain Search)
 - You can select or deselect the search bank freely by pressing the corresponding number with the keypad.
 - The scanner automatically increases its search speed from 100 to 300 steps per second for the bands having 5 kHz steps. (Turbo Search)
 - Press and hold **▲** or **▼** for more than 2 seconds while searching to switch the search direction.
 - When searching in WFM, it stops before reaching the desired frequency if the step is other than 50 kHz or 100 kHz.
 - After you have set the Search Range through the Menu the first time for a bank, you will be able to set new ranges for the same bank by using the keypad and the standard direct entry method.

Note: After you have entered the search range in a selected bank while still in the menu mode, you can set your alpha tag (see page 19), change the step size of the search, or change the mode. Once the lower and upper parameters of your search are edited, the menu screen backs up one level to allow you to modify the step size, receive mode, and alpha tag. Select **2: STEPS** for your step size choices and then

press **E**. Select **3: MODE** for the receiver mode choices and then press **E**. Select **4: ALPHA TAG** to enter an alpha tag using the **VFO** control.

Search Hold Feature

1. Press **HOLD/▲** at anytime to stop the search.
2. Press **HOLD/▲** to move to the next higher frequency.
— OR —
Press **LIMIT/▼** to move down to the previous frequency.
3. Press **SRCH** to resume searching.

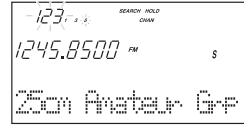

Data Skip

A scanner will normally stop on any transmission it receives. This means the UBC780XLT will occasionally stop on data signals and unmodulated transmissions. You can automatically skip many of these types of transmissions during search. To activate the data skip feature, enter into the menu mode.

1. Press **MENU**.
2. Press **▲** or **▼** to select **SYSTEM DATA** and then press **E**.
3. Press **▲** or **▼** to select **DATA SKIP** and then press **E**.
4. Set to **ON** using **▲**, **▼** or **VFO** and then press **E**.
DATA appears on the display.

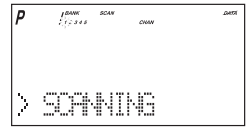

When data skip is active, your scanner may pause momentarily on an unwanted signal but will resume searching in 2 or 3 seconds. Data Skip does not function during AM/WFM band scan, chain search, or SVC search, Priority Scan, and Trunking Mode.

Frequency Skip

If a particular frequency continues to interrupt search scanning, it is possible to set your scanner to skip the frequency.

To skip over a frequency, press **L/O** when stopping at the frequency you want to skip.

- Note:**
- You can program up to 200 skip frequencies. The 201st skip frequency entered causes the first skipped frequency to unlock.
 - If all frequencies in the search range are set to skip, it moves to Search hold mode. To resume searching, do as follows:
 - 1) Cancel the frequency skip set, or
 - 2) Reset the search frequency range.

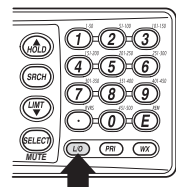

To cancel all skipped frequencies, press and hold **L/O** for 2 seconds.

Storing Search Frequencies

You can quickly store any frequency you find during Search.

Caution: You must select the channel in which you will store the frequency before entering the search mode. Otherwise, you may erase a stored frequency that you want to keep.

1. During search, press **HOLD/▲** when the scanner stops at the frequency you want to store.
2. Press **E** to store the frequency in the channel you selected.



Note: • If the frequency you want to store exists already, **WARNING** appears on the display with a beep. (See Duplicate Frequency Alert on page 19.)

- After storing the frequency, it moves to the manual mode.
3. To store another frequency, select another channel for the new frequency by pressing **MAN** or **HOLD/▲** or **LIMIT/▼**.
 4. Repeat steps 1 and 2 after starting search for all the Search frequencies you want to store.

Auto Storing

The scanner automatically stores searched frequencies if its auto store feature is activated.

To make use of this feature, set a search range first (see page 26), then enter into the menu mode.

1. Press **MENU**.
2. Press **▲** or **▼** to select **SEARCH EVENT** and then press **E**.
3. Press **▲** or **▼** to select **AUTO STORE** and then press **E**.
4. Set to **ON** using **▲**, **▼** or **VFO** and pressing **E**. All bank numbers start flashing and **AUTO** is lit on the display.
5. Select the bank numbers you want to use with the keypad. The selected bank numbers stop flashing.



Note: If the selected bank has no free channels to store, **ERROR** will appear on the display with a beep.

6. Press **SRCH** to start auto storing. The **AUTO** icon on the display begins to flash. Audio is muted during the storing process.
7. After the search has gone through the search range, press **MAN** or **MENU** to stop this feature. **STORE END** appears in the display. You may want to let it run through the search range again because during the first pass there may not be any transmissions at that particular time.



 **Remember!** You can also use the **VFO** control for scrolling. Also instead of pressing **E**, you can press the **VFO/SELECT** control or press the **SELECT/MUTE** key.

Squelch (SQ) Mode

The scanner can be set to the following SQ modes.

- **Carrier SQ mode** (default setting)
The scanner will stop on any transmission or squelch opening, regardless of whether any sub-audible tone has been programmed for the channel or search range.
- **Tone SQ mode**
The scanner will stop on any active frequency for which either no sub-audible tone has been programmed or for which the user-programmed sub-audible tone is also active.
- **Tone Search mode**
During any transmission, the scanner will begin searching all possible sub-audible tones, one of which may also be in use. The scanner counts up through the CTCSS tones and instantly determines any possible DCS tone. See Page 83 for a listing of the tones that the UBC780XLT decodes.

Note: When Tone Search is active in Scan Mode, once the CTCSS/DCS display flashes a tone repeatedly (meaning that it has found the tone match), you can press **E** to program that frequency with the captured tone. When you change the mode to Tone Squelch from Tone Search, that frequency and tone will be programmed.
- **Tone Lock (out) mode**
For either a memory channel or a search range, you can lock a particular sub-audible tone by pressing **L/O** after scrolling to the desired tone. The scanner will stop on any transmission except those which may be using the locked sub-audible.

To set your scanner, enter into the menu mode.

1. Press **MENU**.
2. Press **▲** or **▼** to select **SYSTEM DATA** and then press **E**.
3. Press **▲** or **▼** to select **SQ MODE** and then press **E**.
4. Press **▲** or **▼** to select one type (CSQ, Tone SQ, Tone Search) and then press **E**.
5. To set Tone Lock mode, do the following first, then select Tone SQ in step 4.
 - 1) For scan mode, enter **CH DATA - CH No. - TONE DATA**, select CTCSS/DCS with **▲** or **▼**, set Tone Lock ON by pressing **L/O**.
 - 2) For search mode, enter **SEARCH EVENT - TONE DATA**, select CTCSS/DCS with **▲** or **▼**, set Tone Lock ON by pressing **L/O**.

Note:

- CTCSS: Continuous Tone Coded Squelch System.
- DCS: Digital Coded Squelch.

- For example, the scanner shows the following displays

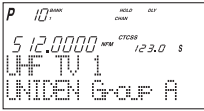

Tone SQ on,
CTCSS 123.0 Hz set



Tone SQ on,
DCS 325 set



Tone SQ on,
No CTCSS & DCS set

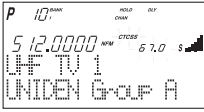

Tone Search,
CTCSS 67.0 Hz detected

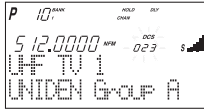

Tone Search,
DCS 023 detected



Tone Search,
no signal present

- If the delay feature (-2 sec/-5 sec/-10 sec) has been set while in Tone search mode, it resumes scanning according to the delay setting.

Additional Menu Options for Searching

Each of these additional menu options apply to all banks with search ranges entered. If there is a bank that you do not want an option to apply, then simply press the bank number on the numerical keypad. You will see the bank number that you have selected, disappears from the display. (For more information on these options refer to the “Menu Descriptions” section and “Additional Features” section.

Options:

RECORD (for more information see page 9)

1. Press **MENU**.
2. Press **▲** or **▼** to select **SEARCH EVENT** and then press **E**.
3. Press **▲** or **▼** to select **RECORD** and then press **E**.
4. Set to **ON** using **▲**, **▼** or **VFO** and pressing **E**.
LINE is lit on the display.

ATTENUATOR (for more information see page 22)

1. Press **MENU**.
2. Press **▲** or **▼** to select **SEARCH EVENT** and then press **E**.
3. Press **▲** or **▼** to select **ATTENUATOR** and then press **E**.
4. Set to **ON** using **▲**, **▼** or **VFO** and pressing **E**.
ATT is lit on the display.

DELAY

Refer to page 22.

Service Search

The Service Search feature allows you to toggle through the following five preprogrammed services. The frequencies selected for these services are the most commonly used around the Australia.

- 1: POLICE
- 2: RAILROAD
- 3: AIR
- 4: MARINE
- 5: UHF CB

1. Press **SVC** the display indicates as illustrated.
2. After a 3 second delay, searching begins for the first preprogrammed service – Police (initial setting).
3. If you want to skip a frequency, press **SRCH** to start searching immediately.
4. To change the searched service, use **▲**, **▼** or **VFO** after pressing **SVC**.

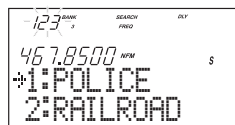

- Note:**
- You can not change such settings as delay, during a service search.
 - The channel number corresponding to certain services will appear when a frequency within the search is active.
 - You can enter one of the Service Search frequencies into Channel Memory by pressing **E** when holding on one of the frequencies.
5. To exit from the service search mode, press **MAN** or **SCAN**.

During the search of one of the preprogrammed services, the lower display line will indicate the service that you are searching. To stop the search, press **HOLD/▲**. **HOLD** appears in the display. Press **HOLD/▲** or **LIMIT/▼** to move up or down one programmed frequency, or press **SRCH** to resume scanning.

Service Search Skip

You can set the scanner to skip the frequencies unwanted during service search. 100 skipped frequencies are programmable.

1. To skip over a frequency, press **L/O** when stopping at the frequency you want to skip.
2. To cancel a skip during search, press **HOLD/▲**, tune in the desired frequency using **▲**, **▼** or **VFO**, then press **L/O**.

To restore all skipped frequencies, press **L/O** for 2 seconds.

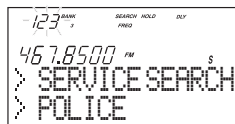

Trunked Systems

Your UBC780XLT is designed to track three major types of trunked radio systems. These systems are described here.

❖ **MOTOROLA** - Including Type I, Type II, Hybrid, SMARTNET, and Privacy Plus.

Motorola systems are widely used by public safety and business users. Most are on the 800 MHz band, and recent systems are appearing on other bands.

❖ **EDACS** - Including "Wideband" 9600 baud, and "Narrowband" 4800 baud systems.

"Wideband" systems are mostly on the 800 MHz band, and are used by public safety, utilities, and business users. Some systems are used on the VHF and UHF bands.

"Narrowband" systems are used in the 935-940 MHz band, many by utilities.

(See page 49)

❖ **LTR** - These systems are mostly for business users, and found on the UHF, 800 and 900 MHz bands. (See page 48)

For details on the operation and programming for all of these systems, see pages 32-34.

When tracking these types of systems, remember these important points:

- Your scanner defaults to monitor Motorola Type II systems; however, you can change this if the system in your area is different. (The types of systems are discussed in the following pages.)

Note: *Motorola, SMARTNET, and PRIVACY PLUS are trademarks of Motorola Inc. EDACS is a registered trademark of the Ericsson Corporation. LTR is a registered trademark of E.F. Johnson Company.

Programming and Receiving Trunked Systems

Programming Trunking Frequencies

The first step in tracking a trunked system is storing the frequencies in one of the 10 available banks in your scanner. Remember that you can only store one trunking system in each bank.

Important: If you are programming an EDACS or LTR trunked system, you must enter the frequencies in a specific order. Check the frequency guide included with the scanner for the frequencies in your area.

1. Press **MENU**.
2. Press **▲** or **▼** to select **TRUNK DATA** and then press **E**.
3. Press **▲** or **▼** to select the bank no. and then press **E**.
4. Press **▲** or **▼** to select the **TRUNK TYPE** and then press **E**.

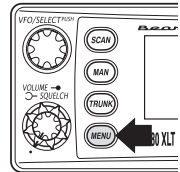

Remember! You can also use the **VFO** control for scrolling. Also instead of pressing **E**, you can press the **VFO/SELECT** control or press the **SELECT/MUTE** key.

5. Choose the system you want to track using the keypad, **▲** or **▼** and then press **E**.

No.	LCD display	Icon	Trunking Type	Special requirements
1	Type 2 800	M	Motorola Type 2 800 MHz	
2	Type 1	M	Motorola Type 1	a. Must program a fleet map.
3	Type 2 900	M	Motorola Type 2 900 MHz	
4	Type 2 UHF	M	Motorola Type 2 UHF	b. Must program base, spacing, frequency and offset channel.
5	Type 2 VHF	M	Motorola Type 2 VHF	
6	EDCS WIDE	E	EDACS Wideband 9600 baud	c. Must program frequencies
7	EDCS Narrow	E	EDACS Narrowband 4800 baud	in exact order
8	LT	L	LTR	and location.

4. To exit from this mode, press **MENU** repeatedly.
5. Select a channel using the keypad and then press **MAN**.
6. Enter a frequency for the trunked system using the keypad.
For example, enter **867.8375** (Type 2) or enter a frequency you are going to track.

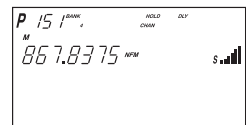

 **Important!**

7. Press **TRUNK** for 2 seconds.
A tone sounds, and E, M, or L icon appears on the display according to the system selected.

Note: • To clear a mistake while entering the frequency, press  (decimal key) repeatedly until the display is cleared.

- If you enter a frequency which is out of the system's trunking range, a distinctive beep sounds and ERROR appears on the display.
- Repeat Step 7 for every trunk frequency entered.

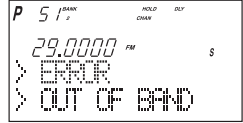

Selecting Trunking Programming Menu Mode

To change the system type which your scanner monitors, you must be in the Trunking Programming menu mode.

To select this mode, follow these steps:

1. Press **MENU**.
2. Press **▲** or **▼** to select **TRUNK DATA** and then press **E**.
3. Select the bank you want to program using **▲**, **▼** or **VFO** and then press **E**.

 **Remember!** You can also use the **VFO** control for scrolling. Also instead of pressing **E**, you can press the **VFO/SELECT** control or press the **SELECT/MUTE** key.

Selecting Trunking System Type

1. Select **TRUNK TYPE** using **▲**, **▼** or **VFO** and then press **E**, **SELECT** or **VFO**.
2. Select the system type you want to program using **▲**, **▼** or **VFO** and then press **E**, **SELECT** or **VFO**.

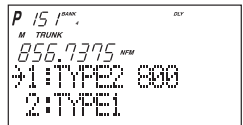
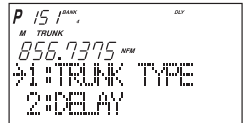

Setting the Squelch

For trunked reception, a good setting for the **SQUELCH** control is in the centre of the range with the red marker pointing up. See the illustration.

If set too high (CCW) in some cases it could prevent your scanner from locking to the control channel reliably. If set too low (CW) it will slightly delay finding the control channel. The best setting is the same as for conventional reception, and is not critical.

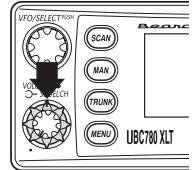

Receiving Trunked Systems

When you have properly programmed all the frequencies for a trunked system, you can receive the system several different ways. You will find that Search, Hold, Lockout, Scan and Manual are all similar to conventional scanning.

- ❖ **TRUNKED SEARCH** lets you hear all system talkgroup activity (unit-to-unit I-Calls may be received as well). This is the best way to get started.
- ❖ **ID HOLD** works with Search mode to let you quickly freeze reception on an interesting transmission. Or you can manually specify a talkgroup with **DIRECT ENTRY ID HOLD**.
- ❖ **ID LOCKOUT** works with Search to exclude talkgroups that you don't want to hear.
- ❖ **ID SCAN** lets you receive only those talkgroups that you store in Scan Lists.
- ❖ **MANUAL** lets to selectively listen to a talkgroup in your Scan Lists

When receiving EDACS systems, remember that Uniden's AFS talkgroups give you powerful flexibility. In a few keystrokes, you can specify a single talkgroup, a fleet, or an entire agency in all the above modes. Read the section "EDACS Reception" to understand how this works.

Trunked Search

Once you have programmed all the frequencies for a trunked system, **SEARCH** will let you immediately start hearing transmissions. It is suggested you try **SEARCH** mode first.

1. Press **SCAN**, and select the bank(s) you wish to receive, just as you select banks in conventional scanning.
2. Press **TRUNK** to enable trunked reception. The radio will seek and acquire the trunked system control channel. The scanner will now be in **MONITOR** mode. You will hear the control channel and see active talkgroups on the screen. You will not hear the voice transmissions in **MONITOR** mode.

👉 **Hint:** **MONITOR** mode is an excellent way to observe system activity and determine which talkgroups are most active. Locked-out IDs display during **MONITOR** mode.
3. Press **SRCH** to begin searching and receiving. You will hear talkgroups and see them on the screen.

Talkgroups display differently in Motorola, EDACS and LTR systems. You should read the appropriate parts of this guide to understand the formats.

The bottom line of the display indicates the Bank and the type of trunked system you are monitoring. You can change this to display a bank tag by using the System Menu.

Regardless of the system, you won't know exactly who you are receiving until you listen for a while. Of course, figuring out who each ID represents is half the fun of TrunkTracking.

Later, when you learn more about a system, you will want to store lists of talkgroups. Then you can scan specific agencies and users, and use the many other features your radio provides.

ID Hold and Direct Entry ID Hold Mode

Just like in conventional Search, HOLD lets you pause ID Search on an interesting transmission without storing the talkgroup into memory.

If you hear an interesting ID during SEARCH mode, and want to continue listening to it --

- Press **HOLD/▲** to stop the search. HOLD appears in the display.

If you want to listen to a specific ID, while in HOLD --

- Use the keypad to enter the ID you want and press **HOLD/▲**. HOLD appears in the display.

If you want to stop holding --

- Press **SRCH** to return to Search Mode.

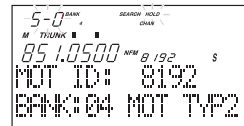

ID Lockout

Like conventional scanning, it's possible to lockout unwanted traffic. This is particularly important in trunked systems because in many areas, water meters, door alarms, traffic signals, and other mechanical devices are assigned IDs just like other users. Also some users scramble or encrypt their communications, and you may want to lock out these unintelligible broadcasts.

To lockout an ID, press **L/O** when the ID displays.

The ID is locked out. You can lockout up to 200 IDs.

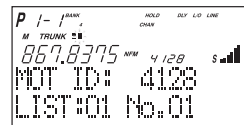

Note: If you lockout an ID in Search mode, it is also locked out in Scan List mode.

Conversely, if you lockout an ID while in Scan List mode, it is locked out in Search mode. For information about Scan Lists see page 42.

EDACS BLOCKOUT is a powerful form of ID LOCKOUT that can be used only with AFS and EDACS systems. This feature lets you lock out entire Agencies or Fleets, not just individual talkgroups. Using ID BLOCKOUT you can, for example, prevent Search from stopping on any of hundreds of talkgroups in the Utilities agency. You can do this with just a few keystrokes. To use ID BLOCKOUT just enter the Agency- part, or the Agency-Fleet part, of the talkgroup code and press **L/O**. For example, to Blockout Agency 4 in Trunk Search, press **HOLD/▲**, 04, **○** (decimal key), and then **L/O**. For other ways to use partial AFS entry, be sure to read the section "EDACS Reception".

Restoring Locked-out IDs

To unlock a single ID, follow these steps:

1. Press **MENU**.
2. Select **TRUNK DATA - BANK NO. - L/O ID REVIEW** using **▲**, **▼** or **VFO** and pressing **E**, **SELECT** or **VFO**.
3. Select the locked out ID you want to unlock using **▲** or **▼**.
4. Press **L/O**. The ID is unlocked and the next locked ID displays.

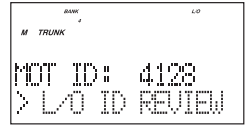

To unlock all locked out IDs in a bank at once:

1. Press **E** instead of **L/O** in step 4 above.
2. To exit from this mode, press **MENU** repeatedly.

Channel Activity Indicators

The UBC780XLT has 30 Channel Activity Indicators to visually display a trunked systems activity. You'll always know which frequencies are in use and how much communication traffic is occurring.

Each frequency you program in a trunking bank corresponds to an activity indicator at the top of your scanners display. The way in which the Activity Indicators display provide you with information about the system you're tracking.

- The indicator which remains on, even if when there is no traffic, represents the frequency being used as the data channel.
- If an indicator turns on and you don't hear a conversation, then the channel may be used as a telephone interconnect call (some systems) or a talkgroup that has been locked out.
- The indicator which flashes when an ID displays represents the frequency being used by the talkgroup.



- If you're holding on an ID which isn't active, the activity indicators will turn on and off as other groups use the system.

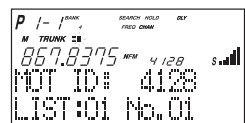
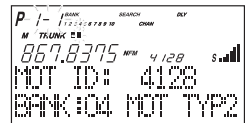

Scan Lists

Each bank of your UBC780XLT can be a trunk tracking bank and it can be a conventional scanning bank. When you designate a bank as a trunking bank, your scanner sets up 10 Scan Lists, which are simply lists used to store your favourite IDs. Each list can contain up to 10 IDs, so you can store a total of 100 IDs for each trunk tracking bank. (1000 if you use all banks as trunking banks!)

Scan Lists help you organise the trunking system users into categories.

For example, you might use List#1 for police IDs, List#2 for fire department IDs, List#3 for emergency medical service IDs, etc. Once IDs are stored in lists, you can scan them like you scan conventional frequencies and you can lock out any one (and up to 9) of the 10 scan lists by pressing the corresponding numeric key. When an ID is active, the scan list number icon into which it is programmed will flash in the display (when the LIST icon is also active – see below). You can program your scan lists either manually or during trunking search mode.

SELECT Key

Use the **SELECT** key while trunking to toggle between viewing the active Banks and the active Scan Lists. To see which is currently active, check the display for either the **BANK** or the **LIST** icon.

Programming ID Scan Lists Manually

1. Press **MAN**, the lowest available ID list number appears on the display.
2. Use **HOLD/▲** and **LIMIT/▼** to select the Scan List location you want to program.
For example, select the third memory location in the fifth scan list.



Note: You can also use the keypad to input directly.

3. Enter the Type II ID you want to store, and press **E**.

— OR —

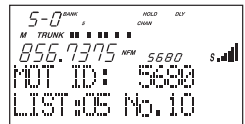

To enter a Type I ID:

- a. Enter the block number and fleet number.
- b. Press **0**.
- c. Enter the subfleet number, and press **E**.

— OR —

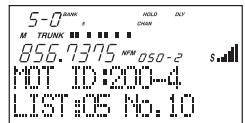

To enter an EDACS® ID:

- Enter ID you want to store.
Use the  for the “dash”.
- Press **E**.

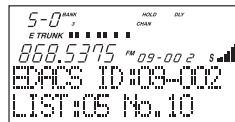



Hint: Remember that Uniden's AFS format allows you to enter full or partial EDACS IDs for powerful flexibility in all modes. Be sure to read the section "EDACS Reception" on page 49 to learn how this works.

Note: The UBC780XLT defaults to “AFS” talkgroup displays for EDACS® only.

— OR —

To enter a LTR ID:

- Enter Area code and then press .
- Enter Home Repeater number and then press .
- Enter ID you want to store and then press **E**.

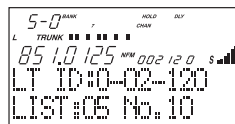

Note: To clear a mistake while entering an ID, press  and **E** successively, and start over.

- Press **MAN** or **HOLD/▲** to select the next Scan List location.

Program ID Manually with the Menu Mode

Note: It is also possible to do ID programming in the menu mode by selecting TRUNK DATA - BANK NO. - PROGRAM ID. Do the following:

- Press **MENU**.
- Press **▲** or **▼** to select **TRUNK DATA** and then press **E**.
- Press **▲** or **▼** to select the bank no. and then press **E**.
- Press **▲** or **▼** to select the **PROGRAM ID** and then press **E**.

 **Remember!** You can also use the **VFO** control for scrolling. Also instead of pressing **E**, you can press the **VFO/SELECT** control or press the **SELECT/MUTE** key.

- Select the ID location using the VFO control, keypad, **▲** or **▼** and then press **E**. (first number represents the bank number and second number represents the memory location.)(Direct entry method example: enter “5-1” by pressing **5**, , **1**.)
- Press **▲** or **▼** to select **ID** and then press **E**.
- Enter the ID number using the keypad and then press **E**.

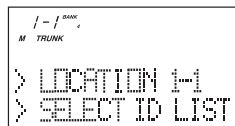

Note: After you have programmed the ID in a selected bank while still in the menu mode, you can set your alpha tag (see page 19), flag the individual ID or talkgroup for recording (see page 30 and 9), or turn on the beep alert for an individual talkgroup (see page 20).

ID Scan Mode

1. Press **SCAN** to begin scanning the lists you have programmed.

If you haven't programmed any IDs, **ERROR** appears for a few seconds.

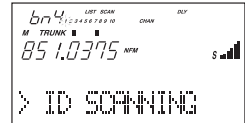

2. To remove a Scan List from active scanning, press the number of the Scan List on your keypad.

The Scan List indicator turns off, and the IDs in that list are not scanned.

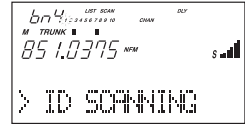

Note: One Scan List must always be active. If you try and deactivate all the Scan Lists, Scan List 1 will automatically be active.

3. To restore a Scan List to active scanning, press its number again.

4. Press **SRCH** to return to Trunk Tracking Search mode. For motorola and EDACS system, to change your display between the Scan List indicators and trunk bank display, press **SELECT**.

For LTR systems only, the talkgroup must be active in order to change the scan list and bank indicators. If the talkgroup is not active, change the scan list by using the menu screen.

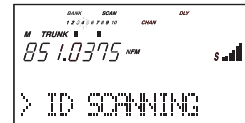

Note: • Once you press **SCAN** or **SRCH** in one bank, all trunking banks will change to that mode.

- Selecting a Scan List is also possible in the menu mode. (LTR only)
- **ID SCANNING** appears on the bottom of the screen during Trunk Scan instead of simply **SCANNING**.

Setting Priority in Trunking Mode

You can set priority in your trunking lists, just as you do in your conventional ones. You can set the priority by pressing and holding **PRI** for 2 seconds. After you've set up your Scan List, press **PRI** to activate it.

It's very similar to conventional priority although there is no "interrupt" during the transmissions. Priorities are checked in between transmissions.

With Priority on, you can hold on an ID in your Scan List, such as Scan List 6, memory position 7, and the scanner will check all the priorities in all the active Scan Lists every few seconds and in between any transmissions on the ID on which you're holding. The lowest numbered priority will be checked first. For example, the priority ID in List 1 will be checked before the priority in List 2, etc.

Note: This function does not work in LTR tracking.

Programming Scan Lists During Search

To select a Scan List location and store an ID during Search mode, follow these steps:

1. When your scanner stops on an ID you want to store, press **HOLD/▲**.
2. Press **E**, or use **HOLD/▲** or **LIMIT/▼** to select the Scan List memory location you want to change, then press **E**.
3. Press **SRCH** to return to Trunk Tracking Search mode.

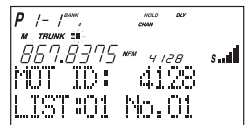
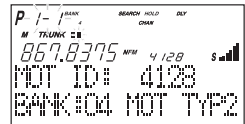

Deleting a Stored ID

To delete a stored ID:

- a. Press **MAN**.
- b. Use **HOLD/▲** and **LIMIT/▼** to select the scan list location you want to delete.
- c. Press **0**.
- d. Then press **E**.

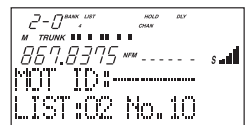

Moving between Scan List Memories

There are a number of ways to step and move through your Scan List memories:

1. Press **MAN** repeatedly.
2. Or, press **MAN**, then press **HOLD/▲** or **LIMIT/▼**.
3. Or, press **MAN**, next press **0 - 9** (scan list number), then press **0 - 9** (memory position), for example. To move to Scan List 4, memory position 10, press: **MAN, 4, 0, MAN**

I-Call (Motorola/EDACS)

I-Calls are direct unit-to-unit transmissions that are not heard by other system users. Your UBC780XLT can receive these transmissions. How you receive I-Calls depends on whether you are in Search or Scan mode.

During I-Call reception the display will show the Unit ID number of either the transmitting or receiving mobile unit, not a talkgroup. Unit IDs will display differently according to the type of trunked system, and will replace the 'n's shown here.

EDACS and MOTOROLA TYPE 1 i n n n n n

MOTOROLA TYPE 2 7 n n n n n n

Hint -- There are thousands of Unit IDs in typical systems, but relatively few I-Calls at a given moment, so it is normally best to let the scanner to receive any I-Call without trying to specify particular units.



I-CALLS IN SEARCH MODE

In SEARCH mode, the scanner default is that I-Call reception is OFF. This means that I-Calls will not be received until you program them to be ON. You have three choices for controlling I-Call reception. Through the Menu system, go to TRUNK DATA / BANK NO / I-CALL , and make your selection. The menu choices are:

		I-CALLs	TALKGROUPS	
1	OFF	Not received	Received normally	This is the UBC780XLT default
2	ON	YES	Received normally	Use this choice to receive I-Calls together with normal talkgroup traffic.
3	ONLY	YES	NOT RECEIVED	Use this setting to listen to I-Calls, and block all talkgroup reception. For quick access to this mode, press  then SRCH .

In I-Call ONLY mode, the display will show I-CALL, to warn that only I-Calls will be received.

You can HOLD any I-Call ID. Because you can only hold on one ID, and there are two IDs involved in any I-Call communication (the transmitting and the receiving units), you might not hear the full conversation, but you probably will.

 In SEARCH mode, when you hear an interesting I-Call, you can enter the instant shortcut  then **SRCH** to enter I-Call ONLY mode. This blocks all talkgroup traffic and lets you hear just the I-Call. To return to normal reception, you must use the Menu system to select the ON or OFF option.

Note: When storing I-Call IDs, remember that the ID will be for only one of the units -- either the transmitting or receiving unit. Unless you specifically want to receive a certain ID, it might be better to use the special code in the HINT below.

I-CALLS IN SCAN AND MANUAL MODE

You can store I-Call IDs in scanlists, just like talkgroup IDs, for use by ID Scan and Manual modes. To program a specific I-Call Unit ID into a scanlist:

EDACS or Motorola Type 1

Enter \odot followed by the Unit ID digits, then **E**.

Motorola Type 2

Enter **7** followed by the Unit ID digits, then **E**.

HINT - There is a special code to let you receive all I-Call IDs with a single scanlist entry. Simply enter \odot , **0**, **E**. This will store the special code **i0** in an EDACS scanlist, or **700000** in a Motorola scanlist. Then, whenever you SCAN this entry, or select it in MANUAL, the scanner will receive any active I-Calls, regardless of the Unit IDs.

Note: Motorola I-CALL tracking performance may vary between systems.

Multi-Track

The UBC780XLT allows you to track more than one system at a time. Here are some highlights of this feature:

- ❖ You can actually track up to 10 trunking systems at one time.
- ❖ You can trunk scan or search and scan conventional frequencies at the same time.
- ❖ You can program conventional frequencies in the same bank as trunking systems. After the scanner finishes checking a trunked system for activity, it will conventionally scan the other frequencies in the bank (remember, only trunking frequencies are programmed in TRUNK mode).

To scan a mix of trunking and conventional banks, select the banks you wish to be active with trunking off, then press **TRUNK**. The scanner will instantly begin scanning. If you have not programmed a trunking bank with talkgroup ID's, you will receive **NO ID (-----)** message for that bank. You can switch to SEARCH mode and the scanner will search for any active ID's on the system.

Multi-Track Operational Details

When more than one trunk system is active (for example two or more trunked systems or a trunked system and one or more conventional frequencies), the radio jumps between systems/frequencies as follows:

TRUNK SCAN: The scanner moves to a trunked system and looks for IDs in your Scan List(s) for up to one second. If it finds no activity on your programmed talkgroups, it moves on to conventional channels in the same bank or to the next active bank.

If the scanner finds that a talkgroup in one of your active Scan Lists is on the air, you will begin to hear that communication and the scanner will of course display the proper talkgroup number and any alpha tag. When the communication ends, the scanner will wait for any delay period (such as a default of two seconds) for any further replies and, if none, the scanner will move to the conventional channels in the same bank or to the next bank. The scanner will not look for any other IDs within the same trunked system (as this would slow the scan process). Note that if you press **SCAN** while you are listening to one ID, the scanner will check to see if another ID in your Scan List is active. It will disregard the ID to which you were just monitoring.

TRUNK SEARCH: This mode works similarly to TRUNK SCAN. If the scanner finds any (non-locked-out) ID when it checks the control channel, you will hear it. You will then hear any replies that follow within two seconds (or whatever delay you may have set). After that the scanner will move on and not continuously search the system for additional IDs (on busy systems you would never leave the system if this were the case). Note that if you press the **SRCH** key while monitoring one ID, the radio will check if any other IDs are active (it will disregard the ID you just left), and if none are active, it will move on.

LIMIT/▼ KEY: If you wish to exit a trunked system without waiting for the currently active talkgroup to finish its communication, press the **LIMIT/▼** key. This is particularly helpful on very busy systems where many talkgroups are active and activity is frequent and long-lasting. Pressing this key will move the scanner on to the conventional frequencies in the same bank or the next bank.

SCAN & SEARCH Icons

For the first time on a Uniden scanner, you will see both the **SCAN** and the **SEARCH** icons active at the same time. This indicates that the radio is scanning conventional banks and Trunk searching trunking banks. When the radio is trunking, only the **SEARCH** icon will be lit. Note that to start a conventional search, you must place the radio into conventional manual mode and then press the **SEARCH** key.

EDACS® Reception

EDACS® Tracking

TrunkTracker III now allows tracking of EDACS® trunked systems. Until now these widely used systems have been almost impossible to monitor with a conventional scanner. With your TrunkTracker III listening to EDACS(s) is remarkably easy, and perhaps even easier than conventional scanning.

EDACS systems use 'Transmission Trunking', which means that each transmission is assigned a new frequency. As the conversation moves through the system's frequencies, your TrunkTracker II automatically follows it.

This chart shows a 30 second sample of EDACS transmissions. Eight different talkgroups are using the system as their transmissions switch between the thirteen system frequencies. Notice how the dotted line shows talkgroup 02-023 moving from channel to channel. Your UBC780XLT can clearly and automatically follow this talkgroup, or any other, as you select.

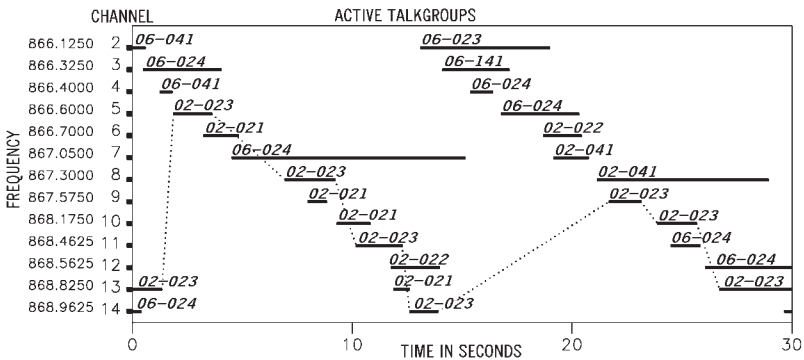

EDACS systems are organised in a logical way that keeps related talkgroups together. Your scanner is designed to take maximum advantage of this organisation to make your scanning easy. It lets you zero in on just the part of the system you want to hear, whether it is an individual channel or an entire department or city.

Programming EDACS System Frequencies

When you program EDACS frequencies, it is critical that you store each one in the CORRECT LOCATION. By the nature of EDACS systems this is necessary for tracking. This often is not the frequency order, so you must be sure you have the right sequence.

An EDACS® Trunked system

This chart shows how talkgroups are organised within an EDACS system at the AGENCY level. The individual talkgroups cannot be shown at this scale because there are over 2000. However the chart can show the 16 Agencies in this example. The system is logical and easy to understand. EDACS systems are typically arranged in an outline structure.

The system users are given blocks of talkgroups. Sizes vary but most large cities and other agencies have blocks of 128 channels. Smaller cities have only 64 or 32 channels.

In this example, the County Sheriff is agency 01. The city of Sullivan is Agency 03. Adams Hill and Matthew Junction share Agency 08.

Your scanner shows EDACS talkgroups in AFS (Agency-Fleet-Subfleet) format. This helps you see, at a glance, who you are monitoring. And with the partial-entry feature you can easily include nearby, related channels in the same Fleet or Agency. You can just as easily exclude entire unwanted Fleets and Agencies.

When in Search mode, with the system frequencies programmed, and your scanner locked to the control channel, you can select a desired city by keying in the AGENCY part of the AFS talkgroup. For example, you can select the entire city of Sullivan with 4 key presses zero, three, 03, **SRCH**.

When you hear an interesting talkgroup, capture it to your scan list by pressing **E** during the transmission. Or HOLD on it by pressing the **HOLD** key.

If you want to monitor the Sullivan Police Dispatch channel (which is talk group 03-062), press zero, three, 03, zero, six, two, **HOLD**.

Your scanner can also work in DECIMAL format. This talkgroup in decimal format is 434. But decimal format does not give you any information about the system hierarchy. For example Sullivan, in decimal, uses channels from 384 to 511. This is not as easy to remember as Agency 03. But decimal is useful if you need to work from decimal talkgroup lists.

AFS	AGENCY	DECIMAL
		000
00		100
01	COUNTY SHERIFF	200
	HOSPITALS	
02	COUNTY FIRE	300
	AMBULANCE	
03	SULLIVAN	400
		500
04	SWANSON	
	BIRMINGHAM	600
	MILLIKEN	
05	RANORA POND	700
	TROUBLE CREEK	
06		800
	COLUMBIA	900
07		1000
	ADAMS HILL	
08	MATTHEW JCT	1100
09	CLIFFORD	1200
10	COUNTY GOVT	1300
		1400
11	BEACONSFIELD	1500
	NEW ELFERS	
12	BRENNAN	1600
	EXMORE	
	OAK VALLEY	
13	MIRANDA CANYON	1700
		1800
14		1900
15		2000

Special EDACS® Features

AFS Partial Entry Feature

AFS is Uniden's method of encoding EDACS talkgroups. AFS stands for 'Agency-Fleet-Subfleet'.

AFS talkgroups are used in all EDACS reception -- in ID SEARCH, ID LOCKOUT and ID SCAN scanlists. The powerful AFS Partial Entry feature designed into the UBC780XLT lets you use either a complete talkgroup code, or just the most significant part.

This feature lets you expand or narrow searching and scanning to one of 4 levels. By entering only the desired part of an AFS talkgroup, you can select 2048 talkgroups, 128 talkgroups, 8 talkgroups, or a single talkgroup. For example, you could program every talkgroup in a police department with just 4 key presses. You can use the AFS Partial Entry feature anywhere that you need to specify EDACS talkgroup.

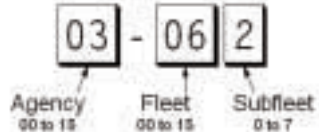

Your UBC780XLT can also enter or display EDACS talkgroups in decimal format (0-2047). Press **MENU - TRUNK DATA**, and for banks selected as EDACS banks, select Item 8, EDACS ID FORM and change it to Decimal. You can use this feature to translate decimal talkgroups lists to the much more powerful AFS format.

Examples of how you might use AFS are shown above in the description of an EDACS trunked system, and elsewhere in this manual. It is very easy to use. Be sure to become familiar with AFS Partial Entry, and your scanning will become far more flexible and efficient.

Emergency Call Alert

Your UBC780XLT alerts you when an EDACS Emergency transmission occurs.

EDACS systems often provide users with an 'Emergency' button on their radios. Users in trouble can alert the dispatcher and other units and get priority access to the radio system. When a user activates Emergency mode your scanner will flash EMERGENCY during the entire transmission. At the beginning of each transmission it will sound a distinctive emergency alert tone three times.

Patch Tracking

The UBC780XLT can follow EDACS patched talkgroups.

EDACS systems sometimes bring several talkgroups together in a 'Patch'. A patch might be used by a police agency at night to provide a single channel with a single dispatcher for a wide area. A patch is created when a single, temporary talkgroup substitutes for the original talkgroups. While the patch is running, which may be for hours or days, the original talkgroups cease to be used. If you were monitoring one of these talkgroups, you might think there was no traffic, but in fact the talkgroup was operating at the different temporary number.

If a talkgroup in your Scan List is patched, your scanner will continue to receive it under its new identity until the patch is ended. When a patch is being received, the radio will display [PATCH ID], and will show the temporary common talkgroup plus all the included talkgroups in a cycling display. The UBC780XLT is limited to following one patch.

The temporary talkgroups used for patches are usually found in AFS code 15-xxx, and sometimes 00-xxx.

LTR[®] Reception

LTR[®] Tracking

LTR[®] (Logic Trunked Radio) systems are trunking systems used primarily by business or private communications service providers, such as taxicabs, delivery trucks, and repair services. These systems encode all trunking information as digital subaudible data that accompanies each transmission. Users on an LTR system are assigned to specific talkgroups, which are identified by the radio as six digit numbers. These numbers are in the form AHHUUU, where:

A= Area code (0 or 1)

H= Home repeater (01 through 20)

U= User ID (000 through 254)

When the scanner receives a transmission on a channel set to the LTR mode, it first decodes the LTR data included with the transmission. In the ID Search mode, the scanner stops on the transmission and displays the talkgroup ID on the display. In the ID Scan mode, the scanner only stops on the transmission if the LTR data matches a talkgroup ID that you have stored in the bank's talkgroup ID list and have not locked out.

LTR systems are frequently programmed so that each radio has a unique ID code.

Motorola Reception

Motorola Tracking

There are really two types of Motorola trunking systems. These are usually referred to as Type I and Type II systems. Type I only occurs on some 800 MHz systems. All VHF, UHF and 900 MHz trunking systems use Type II.

One important distinction between these two systems is the amount of data transmitted by each radio when its push-to-talk button (PTT) is pressed. Every radio in a trunked system is assigned a unique ID so the central site computer can identify it when it's used. Both Type I and Type II systems place radios (or radio users) into groups, called talkgroups, and these talkgroups are also assigned unique IDs. Some radios have access to only one talkgroup, while others have access to many talkgroups. The talkgroup(s) each radio can access is called the radio's affiliation(s).

In a Type II system, when someone uses their radio, only the radio ID is transmitted when PTT is pressed, whereas in a Type I system the radio ID and its current affiliation are both transmitted when PTT is pressed.

Why the difference? Type II systems are slightly more advanced because the central computer maintains a database which is used to determine each radio's affiliation (s). Changes to a Type II system are easier than Type I because the system manager only needs to update the database instead of reprogramming individual radios.

Another difference between the systems is that Type I systems are arranged in a Fleet-Subfleet hierarchy. For example, its possible for a city using a Type I system to designate 4 Fleets, each with 8 Subfleets. Their fleets might be the Police Department, the Fire Department, Utilities, and Administration. The Police may decide to further divide their fleet into subfleets such as Dispatch, Tactical Operations, Detectives, North, South, East and West Side Patrols, and Supervisors. All the available police radios would then be assigned to one of the police subfleets. Determining the exact Fleet-Subfleet hierarchy for a particular area is referred to as Fleet Map Programming, which is discussed further in this manual.

The disadvantage of a Type I system is that when PTT is pressed, the brief burst of data must contain the radio's ID and its Fleet and Subfleet. This is three times the amount of data a Type II system radio sends, and as a result Type I systems usually accommodate fewer users than Type II systems.

Even though there are many Type II systems, Type I systems are still in use. There are also Hybrid systems which are a combination of both Type I and Type II. Your scanner defaults to monitor Type II systems, but its possible to select a Preprogrammed Fleet Map or create a Custom Fleet Map for your area.

For VHF and UHF Type II trunking systems, you will need to know the base, spacing frequencies and offset channels. See page 51 for details.

Fleet Map Programming

If you have programmed a trunk tracking bank for Motorola type and press **TRUNK** to start Multi-Track, you will see user IDs display on your screen. Since the UBC780XLT defaults to Type II systems, all the IDs will appear as numbers. However, if you notice a mix of odd and even user IDs, for example 6477, 2560, 6481, 6144, 1167, etc., then you are probably monitoring either a Type I or Hybrid systems.

You may also notice that you are missing responses when you hold on an active ID. Unlike Type II, Type I/Hybrid systems require a Fleet Map that sets specific Fleet-Subfleet parameters. It is easy to select a Fleet Map for your scanner; what is not always easy is selecting or programming a map that matches your particular area.

There are 16 preset Fleet Maps listed in the appendix that you can choose, and these are usually a good place to start when setting up a Type I/Hybrid trunk tracking bank. If you choose a preset map and still have difficulty following complete conversations, then you'll have to program your own Fleet Map.

Selecting Preset Fleet Map

1. Select **TYPE 1** for the Trunk Type. (Refer to “Selecting Trunking System Type” on page 34.)
2. Select the map you want to program using ▲, ▼ or **VFO** and then press **E**, **SELECT** or **VFO**.
For example, PRESET 16.

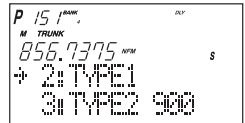

P 15 1^{TRUNK} OFF
M TRUNK
856.7375 S
+ 2 TYPE1
3 TYPE2 900

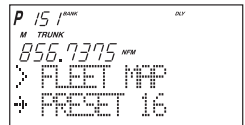

P 15 1^{TRUNK} OFF
M TRUNK
856.7375 S
> FLEET MAP
+ PRESET 16

The scanner returns to the other programming items.

Note: You will now begin to see Type I Fleet-Subfleet IDs. For example, 100-12, 100-9, 000-12, 400-8, etc. See User Defined Fleet Maps in the Appendix for more information about Type I IDs.

How do you know if the preset map is correct? You will have to listen to see if you're following complete conversations. If not, you should try another preset map.

Programming a Fleet Map

You may want to read User Defined Fleet Maps in the Appendix before programming a Fleet Map. It contains a detailed explanation of Scanner Fleet Map Programming, as well as a table listing the Fleet Map Size Codes.

1. Select **TYPE 1** for the Trunk Type. (Refer to “Selecting Trunking System Type” on page 34.)
2. Select **USER CUSTOM** using ▲, ▼ or **VFO** and then press **E**, **SELECT** or **VFO**.

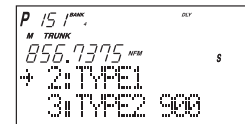

P 15 1^{TRUNK} OFF
M TRUNK
856.7375 S
+ 2 TYPE1
3 TYPE2 900

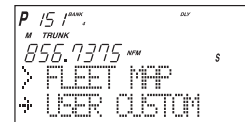

P 15 1^{TRUNK} OFF
M TRUNK
856.7375 S
> FLEET MAP
+ USER CUSTOM

3. Select the size code for the first block using

▲, ▼, or **VFO**.

4. Press **E**, **SELECT**, or **VFO**.

The next available block displays.

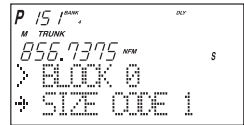

5. Repeat step 3 and 4 until you have selected a size code for each block.

For details about each size code, see Fleet Map Size Codes in the Appendix.

Programming a Hybrid System

A Hybrid system is simply a Type I system with some blocks designated as Type II blocks. To program a Hybrid system, follow the steps listed in Programming a Fleet Map in the previous section. However, if you want a block to be Type II, select Size Code S-0. When you begin searching a trunking bank with a Hybrid Fleet Map, you will see both types of system IDs. That is, Type II IDs usually appear as an even number without a dash; Type I IDs appear as a three or four digit number, followed by a hyphen, followed by a one or two digit number.

Setting the Base, Spacing Frequencies and Offset Channel for Motorola VHF/UHF Trunked Systems

To properly track Motorola VHF and UHF trunked systems you must enter what is known as the base, the spacing frequencies and offset channels for each system.

To enter the base, spacing frequencies and offset channel: (You can set up to three sets of these, but almost all systems only use one set).

1. Press **MENU**.
2. Select **TRUNK DATA - BANK NO. - TRUNK TYPE (TYPE2 UHF or VHF) - BASE CONFIG** using ▲, ▼ or **VFO** and pressing **E**, **SELECT** or **VFO**.
3. Enter a new base frequency with the keypad.

Note: If using a tracking system that uses two (2) or more base frequencies, always program the lowest frequency as Base 1 followed by the next highest frequency as Base 2 with the last or highest frequency as Base 3.

4. Press **E**.
The display changes for entering the spacing frequency.
5. Enter a new spacing frequency with the keypad.

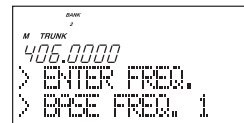

Note: You can only enter within a range of 5-100 kHz, and 5 or 7.5 or 12.5 kHz multiples.

6. Press **E**.
The display changes for entering the offset channel.

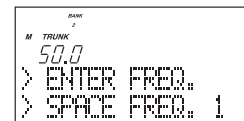

7. Enter a new offset channel with the keypad.

Note: You can only input within a range of 380-759.

8. Press **E**.

The display changes for entering the next base frequency.

9. To exit from this mode, press **MENU** repeatedly.

Note:

- If the system is not tracking properly, you may need to try a new base frequency or offset channel or you may be missing frequencies from the system.

- You can set up to three base, spacing and offsets for Motorola VHF/UHF trunked systems.

10. The offset channel for the first set should be CH380 (just press **E** to confirm this as the default).

11. After you have pressed **E** to confirm CH380, the display will change to allow you to set the second (of a maximum of three) base/space/offset combinations. Since almost all systems only use one set, press **MENU** to exit the programming mode and return to scanning.



Toggling the Status Bit

On Type II trunking systems there is a method by which specialised types of communications utilise unique talkgroup numbers. An emergency call will occur on a unique talkgroup from its primary assignment, for example. Because the UBC780XLT defaults to Status-Bit On mode, you never need to worry about missing these transmissions. If you have programmed talkgroup 33264 into Scan List memory, for example, and there is an emergency call within the group, you will hear it on 33264.

The only time you may wish to turn Status Bits off is if you're trying to figure out the proper fleet map of a Type 1 trunking system. To turn Status Bits off, enter into the menu mode and select **TRUNK DATA - BANK NO. - STATUS BIT**. (This feature does not apply to EDACS and LTR operation within the scanner.) Then use **HOLD/▲** or **LIMIT/▼** to change the setting (on to off) and press **E** to program your change.

Control Channel Only Mode

When this function is activated, trunking is performed using control channel data only. Voice channel (also known as "working channel") frequencies do not have to be programmed into memory. When using this feature, the scanner will display "CC" and channel activity indicator bars will not operate. This feature only applies to Motorola 800 MHz and 900 MHz systems.

To turn this function on, choose Motorola Type-2 800 MHz or 900 MHz or TYPE 1 by selecting **TRUNK DATA - BANK NO. - TRUNK TYPE**. Then set to the desired control plan by selecting **TRUNK DATA - BANK NO. - CTRL CH ONLY**.

You must choose one of 4 frequency plans before you begin to Control Channel Trunk. Note that the default, Plan 1, is the most common. Read the description of the Plans below for details on which may apply for you.

PLAN 1: Use Plan 1 if the last three digits of ALL the frequencies in use end in one of the following three digits: 125, 375, 625, or 875 (example: 865.1125, 865.7375, 865.6625, 866.8875).

PLAN 2: If the last three digits of frequencies less than 870.0000 end in one of the following three digits (125, 375, 625, or 875) AND if ANY other frequencies end in (000, 250, 500, or 750) use Plan 2.

PLAN 3: If the last three digits of ALL the frequencies in use end in one of the following three digits (000, 250, 500, or 750) use Plan 3.

PLAN 4: If the last three digits of frequencies less than 866.0000 end in one of the following three digits (000, 250, 500, or 750) AND if ANY other frequencies end in (125, 375, 625, or 875) use Plan 4.

Of course you will know the Control Channel frequency itself so that will help you determine the proper Plan. If you try one plan and you receive errors (such as the scanner jumping to channels that are obviously not part of the system), you should try an alternate Plan.

Note: You can assign a fleet map to Type 1 or Hybrid systems scanned in Control Channel only mode by going into the menu. You can also program IDs, set delays, alpha tags and all the other parameters for systems scanned in this mode. You can then either search the system to find new IDs or you can program IDs into memory and then scan them.

Note: The Control Channel Only feature is an extremely powerful tool. You can use it to determine if systems you are familiar with may have added new frequencies or you can use it to discover new systems by simply finding active control channels (using Search) and then programming them for Control Channel operation only. Remember that this feature only applies to Motorola 800 and 900 MHz systems, that you do have to set the menu for the proper system type (800 Type 1 or Type II or 900 MHz) and you do have to program the control channel frequency into memory and press and hold the **TRUNK** key to identify the frequency as trunked.

Disconnect Tone Detect Option (End Code)

When this function is disabled, the radio looks for squelch before returning to the control channel instead of waiting for the disconnect tone. Only in rare instances will you need to adjust the default settings.

The condition to return to control channels depends on whether the signal is present or not. To set this function on/off, enter TRUNK DATA - BANK NO. - END CODE.

Remote Interface

You can communicate and program your UBC780XLT in numerous ways with peripheral devices using the Remote Interface Cable port. This radio offers the following modes:

❖ **REMOTE (PC Control) MODE**

Program and control your scanner remotely from a PC using third party software (see the flyer included in the box).

❖ **CLONE MODE**

Clone all the frequencies, trunking talkgroups, and fleet maps programmed into your scanner to another UBC780XLT scanner.

Remote (PC Control) Mode

To connect Scanner to PC:

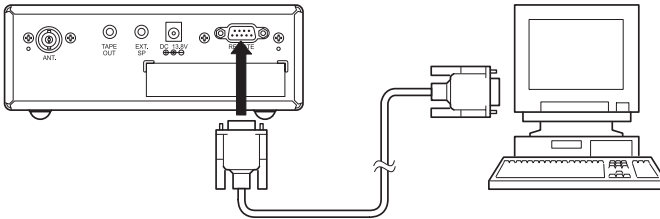

Plug the scanner end of the RS232C straight interface cable (not supplied) into the remote port on the rear of your scanner.

Plug the other end of the cable (DB-9 serial connector) into a personal computer's serial port. A few PCs may require an adaptor, most will not. You may need a DB-9 to DB-25 null modem adaptor, or gender changer adaptor, available at most computer stores. Of course, make sure your PC is turned on.

To program your scanner:

You can program and control your scanner remotely from a PC using third party software. After connecting the scanner to a PC, turn the radio on.

To use the Remote (PC Control) mode, you must purchase third party software and use as directed. Make sure that your scanner is connected to the serial port of the PC using the RS232C straight cable.

Start Remote Mode:

Press **E** key for 2 seconds. REMOTE mode is selected. To distinguish from Normal operation mode, "**RMT**" icon appears.

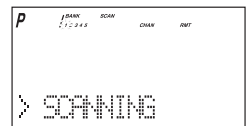

A unique feature of the UBC780XLT is that all the front panel keys as well as the VFO on the radio remain operational in remote mode.

For information on purchasing third party software to program and control your UBC780XLT, see the flyer included in the box with this radio.

PC Control Parameter

For your information:

- Transfer speed : 2400/4800/9600/19200 bps (adjustable)
- Start/Stop : 1 bit, 1 bit
- Data Length : 8 bit
- Parity bit : None
- Code : ASCII code
- Flow Control : None
- Return Code : Carriage Return only

Change Transfer Speed

To change transfer speed, enter into the menu mode.

1. Press **MENU**.
2. Press **▲** or **▼** to select **SYSTEM DATA** and then press **E**.
3. Press **▲** or **▼** to select **PC CONTROL** and then press **E**.
4. To change the transfer speed, press **▲** or **▼**. Then press **E**.

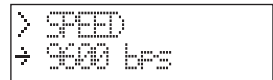

Clone Mode

You will need to purchase an RS232C cable and a null modem adaptor. RS232C cables are available as male to male or male to female. Even if the cable you buy already has the Male to Male connectors, you will still have to have the null modem adaptor. Below you will see the pin connections that are internal to a standard device. (These items are available at your local electronics stores.)

To connect the scanner to scanner:

Plug the male end of the RS232C straight interface cables (not supplied) into the remote port on the rear of one of the two scanners. Then connect the DB-9 to DB-9 null modem adaptor to the cable. Then plug the the other side of the null modem adaptor to the other scanner. (DB9 Gender changers are also available at your local electronics store.)

Null Modem Adaptor
Pin connections

Female DB9	Male DB9
1	4
2	3
3	2
4	6 & 1
5	5
6	4
7	8
8	7
9	Not used

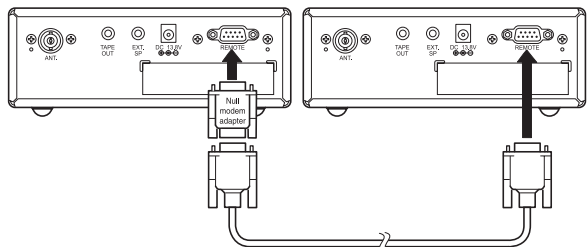

You can clone all of the programming of one UBC780XLT into another, including frequencies, talkgroup IDs, alpha tags, delay settings, etc. After connecting the two scanners, turn the radios on. Prepare each scanner for clone mode as follows.

1. Press **MENU**.
2. Select **SYSTEM DATA - CLONE** using **▲**, **▼** or **VFO** and pressing **E**, **SELECT** or **VFO**.
3. Determine the scanner that has the frequency data that you want to transfer. This one must be set up as the “Master Unit”, and the other must be set as the “Slave Unit”.

4. On the scanner that is the “Master Unit”, select **MASTER**, then press **E**.

```
> SELECT UNIT  
→ MASTER
```

5. On the scanner that is the “Slave Unit”, select **SLAVE**, then press **E**.

```
> SELECT UNIT  
→ SLAVE
```

6. Press the **SCAN** key on both scanners. The data transfer is started from the Master Unit to the Slave Unit.

During the data transfer, both scanners show the following displays.

```
== > >  
> MASTER UNIT
```

```
== < <  
> SLAVE UNIT
```

When the data transfer is completed, **COMPLETE** displays.

```
> COMPLETE  
> MASTER UNIT
```

If the data transfer is not successful, the following error message will appear.

```
> ERROR  
> MASTER UNIT
```

Note: To clear **ERROR**, press **○**.
To exit the clone mode, press the menu key repeatedly.

Note: Once you have completed the cloning of the scanners, reset by turning the scanners off and then on again. This is particularly important to know if you wish to clone another scanner right away.

Additional Features

The following additional features are designed for you to customise your scanner. Once these features have been turned on or off, they will remain as they are set until you reset them, even if you turn the scanner off and then on again.

Dimmer

To change brightness of the display:

1. Press **MENU**.
2. Press **E** to select **SYSTEM DATA**.
3. Press **E** to select **DIMMER**.
4. Select one from **High-Medium-Off** using **▲** or **▼** and then press **E**.

Enter Lock

You can lockout the keypad to prevent any accidental entry. To activate this feature:

1. Press **MENU**.
2. Press **E** to select **SYSTEM DATA**.
3. Press **▼** to select **ENTER LOCK** then press **E**.
4. Set to **ON** using **▲** or **▼** and then press **E**.
The  icon appears on the display when locked.

Key Beep Option

To choose beep sound on or off:

1. Press **MENU**.
2. Press **E** to select **SYSTEM DATA**.
3. Press **▼** to select **KEY BEEP** and then press **E**.
4. Set to **ON** or **OFF** using **▲** or **▼** and then press **E**.

Screen Mask

The trunk, frequency, receiving mode, and signal meter indications on the display are masked when this feature is activated. (except while in Search mode) This feature reduces the amount of displayed information.

1. Press **MENU**.
2. Press **E** to select **SYSTEM DATA**.
3. Press **▼** to select **SCREEN MASK** and then press **E**.
4. Set to **ON** or **OFF** using **▲** or **▼** and then press **E**.
5. To quickly turn off the screen mask, press the **VFO/SELECT** control.

Reverse Mode

This key will allow the user to observe the reverse frequency of the repeater. While pressing  **/RVRS**, the standard pair frequency will be displayed. For a list of the standard pair frequencies, refer to the table "Reverse List" in the Appendix. If the frequency that you have chosen does not have an offset frequency, the second line will indicate the error and display **NO REVERSE**. This feature does not work in the SVC Search mode.

Mute On/Off

To manually turn on the Mute function, press and hold **MUTE** for more than 1 second until the **MUTE ON** is displayed. You will not hear any audio. This feature does not function in the WX alert mode, because the audio is already muted. To turn it off, press **MUTE** again.

Record On/Off

It is possible for you to record every one of the 500 channels or every ID that you have programmed. (up to 1000 IDs). Once you have determined the channels or talkgroups that you want to record, you must mark them to be recorded. Through the menu system, set the **RECORD ON** for each channel, ID, or talkgroup using the **2: CHANNEL DATA** , **3: TRUNK DATA**, or **4: SEARCH EVENT** menu screens. The audio signal from the TAPE OUT Jack on the rear of the scanner will be turned on for each one that was marked. When this feature is set on, the "LINE" icon appears in the display. (Refer to page 9)

Channel Step Selection

You can set channel steps, 5 kHz - 100 kHz or Auto, in Manual mode or Chain search mode. The default receive mode should be the proper mode setting in almost all cases. You may wish to set some VHF channels for NFM mode, depending on any adjacent channel interference problems. Note that WFM is typically only used for broadcast frequencies, such as TV audio or FM radio.

See "STEPS" in Menu Description for details.

Receiving Mode Selection

You can also set the receiving mode, AM or FM etc., in Manual mode or Chain search mode.

See "MODE" in Menu Description for details.

Frequency and Channel Tuning with the VFO Control

The **VFO** knob can be used for changing frequencies or changing memory channels (for conventional channels or talkgroup ID Scan Lists).

1. The default setting is Channel. The **CHAN** icon appears in the display in this setting. In Manual mode, turn the **VFO** control to the right (to step up through channels) or to the left (to step down through channels. If you are in Trunk Manual mode, you will step through Scan List memory locations (whether the **CHAN** or the **FREQ** icon is active).
2. To change the default setting to Frequency, press the **VFO/SELECT** control in Manual mode. The icon will change to **FREQ**. Now turn the **VFO** to the right to step up through frequencies sequentially or to the left to step down through frequencies. To change the step, you will need to go into the Channel Data Menu and adjust the step for the desired memory location.

Care and Maintenance

General Use

- Turn the scanner off before disconnecting the power.
- Always write down the programmed frequencies in the event of memory loss.
- If memory is lost, simply reprogram each channel. The display shows 000.0000 in all channels when there has been a memory loss.
- Always press each button firmly until you hear the entry tone for that key entry, unless you have turned off the **KEY BEEP** in the menu system.

Location

- Do not use the scanner in high-moisture environments such as the kitchen or bathroom.
- Avoid placing the unit in direct sunlight or near heating elements or vents.
- If the scanner receives strong interference or electrical noise, move it or its antenna away from the source of the noise. If possible, a higher elevation, may provide better reception. Also try changing the height or angle of the antenna.

Cleaning

- Disconnect the power to the unit before cleaning.
- Clean the outside of the scanner with a mild detergent. To prevent scratches, do not use abrasive cleaners or solvents. Be careful not to rub the LCD window.
- Do not use excessive amounts of water.

Repairs

- Do not attempt any repair. The scanner contains no user serviceable parts. Contact the Uniden Customer Service Centre or take it to a qualified repair technician.

Birdies

- All radios can receive birdies (undesired signals). If your scanner stops during Scan mode and no sound is heard, it may be receiving a birdie. Birdies are internally generated signals inherent in the electronics of the receiver.

Press **L/O** to lockout the channel, and then press **SCAN** to resume scanning.

Troubleshooting

If your UBC780XLT is not performing properly, try the following steps.

Problem	Suggestion
Scanner won't work.	<ol style="list-style-type: none">1. Check the connections at both ends of the AC Adaptor.2. Turn on the wall switch of your room. You could be using an outlet controlled by the wall switch.3. Move the AC Adaptor to another wall outlet.
Improper reception.	<ol style="list-style-type: none">1. Check the antenna connection or move and reposition the antenna.2. Move the scanner.3. You may be in a remote area which could require an optional multi-band antenna. Check with your dealer or local electronics store.
Scan won't stop.	<ol style="list-style-type: none">1. Adjust squelch threshold - refer to page 10, "Setting the Squelch".2. Check the antenna connection.3. Check to see if many of the channels are locked out. If so, the scanner has less chance of finding an active channel.4. Review each channels frequency to see if it is still stored in memory and is correct.5. Its possible that none of the programmed frequencies are currently active.
Scan won't start.	<ol style="list-style-type: none">1. Press the SCAN key again.2. Adjust the SQUELCH control.3. Check to see if all channels are locked out.
Weather Scan won't work.	<ol style="list-style-type: none">1. Adjust squelch threshold - refer to page 10, "Setting the Squelch".2. Check the antenna.

Problem	Suggestion
Scanner won't track.	<ol style="list-style-type: none"> 1. May not be a system which can be tracked by your scanner. Make sure you press and hold TRUNK for 2 seconds to enter into trunk mode. 2. Missing the data frequency. 3. Change to a Type 1 Scanner setup. Review Fleet Map Programming on page 50.
Scanner won't stop during Scan List mode.	<ol style="list-style-type: none"> 1. No IDs have been programmed. 2. The IDs you have stored are not active.
Scanner will not acquire data channel.	<ol style="list-style-type: none"> 1. Adjust the squelch for trunking mode. See page 39. 2. Missing the frequency used for the data channel. Check your frequency list.
Missing replies to conversations.	<ol style="list-style-type: none"> 1. Change to a Type 1 Scanner setup. Review Fleet Map Programming on page 50. 2. Try another Preset Fleet Map or Program your own Fleet Map. 3. Check to see that all of the systems frequencies have been entered.
Channel Activity Indicators are flashing but no sound is heard.	<ol style="list-style-type: none"> 1. May be a telephone interconnect call, which are intentionally blocked by your scanner. 2. The ID in your display is not active.
Scanner not tracking an EDACS system properly.	<ol style="list-style-type: none"> 1. Logical channel numbers (frequencies) for the system are not programmed in the correct order. Check frequency resources and reprogram. 2. Not all frequencies for the system are programmed. Check frequency resources.

Specifications

UBC780XLT is certified in accordance with AS/NZS 1053.

Channel:	500
Banks:	10 (50 channels each)
Service Bands:	5 preprogrammed search bands
Frequency Range:	25.0000 to 27.9950 MHz CB/Marine CB etc 28.0000 to 69.9900 MHz VHF Low Band 70.0000 to 87.9875 MHz VHF Mid Band 88.0000 to 107.9000 MHz FM Broadcast 108.0000 to 136.9875 MHz Aircraft Band 137.0000 to 147.9950 MHz 2 Meter Amateur Band 148.0000 to 173.9875 MHz VHF High Band 174.0000 to 224.9000 MHz VHF TV 225.0000 to 399.9500 MHz UHF Aircraft Band 400.0000 to 512.0000 MHz UHF Band 806.0000 to 956.0000 MHz 800 MHz Band 1240.0000 to 1300.0000 MHz 25cm Amateur Band
Operating Temperature:	-20 °C to +60 °C
Scan Rate:	100 channels per second (conventional mode)
Search Rate:	100 steps per second (Normal Search) 300 steps per second (Turbo Search)
Audio Output:	Maximum 3.0W (2.3W normal @ 10% THD)
Internal Speaker	8 ohms (56 mm outer diameter)
Power Requirements:	AAD8500U AC Adaptor (13.8V DC, 700mA)
Antenna:	Telescopic Antenna (included)
Antenna Jack:	BNC type
External Jacks:	External Speaker (EXT.SP.) (3.5 mm) DC 13.8 V Power Jack, (centre is positive) Remote Control (REMOTE) Jack (DB-9) Tape Recorder Out (TAPE OUT) Jack (3.5 mm)
Size:	176.5mm (W) x 167mm (D) x 61mm (H)
Weight:	1.33 kg

Features and specifications are all subject to change without notice.

Glossary of Terms

Glossary of terms

Alpha tag - This term refers to an alphanumeric text tag that you can enter to describe the individual frequencies that you have programmed. Rather than having to associate a specific frequency to the individuals that are using it, you can enter the actual name of the group. This will eliminate the need for memorising the group's frequency.

Attenuator - This scanner comes with a feature to attenuate or reduce the signal strength. The built-in attenuator can be turned on specific frequencies to prevent strong signals from overloading the scanner input, possibly damaging the scanner or missing other transmissions due to the repeated stopping on the stronger signal.

Clone - This term identifies the ability to set up a duplicate scanner. This function allows you to clone all the programming information, including frequencies, talkgroups and alpha tags as well as bank settings and other parameters from one UBC780XLT to another.

Control Channel - A Control Channel is the frequency within a trunking system that runs the system. On Control Channels (sometimes called Data Channels) you will hear a buzzsaw sound. For the most part, it is the sound of the system's central computer directing talkgroups to particular voice (working) frequencies within the system.

CTCSS - Continuous Tone Controlled Squelch System- refers to a system where the radio receivers are equipped with tone responsive devices which allow audio signals to appear at the audio output, select voice processing such as scrambling or control repeater functions only when a carrier modulated with a specific tone is received. This method may be used to restrict access to the repeater or receiver, or reduce interference where several stations with output frequencies in close proximity of each other make it difficult to hear the conversation you are interested in. With CTCSS squelching, you can eliminate the possibility of hearing unwanted conversations by selecting one of the 38 standard subaudible tones. You will only hear those transmissions that have been programmed on specific frequencies with the specific subaudible tone that you have selected.

DCS - (Digital Controlled Squelch) refers to a system where the radio receivers are equipped with data burst responsive devices which allow audio signals to appear at the audio output, select voice processing such as scrambling or control repeater functions only when a carrier modulated with specific data burst is received. This method may be used to restrict access to the repeater or receiver, or reduce interference where several stations with output frequencies in close proximity of each other make it difficult to hear the conversation you are interested in. With DCS squelching, you can eliminate the possibility of hearing unwanted conversations by selecting one of the 104 standard data burst subaudible tones. You will only hear those transmissions that have been programmed on specific frequencies with the specific subaudible tone that you have selected.

Enter Lock - This is the term used for locking the keypad. This prevents accidental re-programming of channels and talkgroups entered into memory. The default setting is off.

When **ENTER LOCK** is enabled, the following functions will be disabled:

- Enter or modify the Channel frequency
- Enter or modify the Tone information
- Enter or modify the Trunking ID. (this can be modified through the menu screen.)

I-Call - Most communications within a trunked system are group calls where one unit (such as a dispatcher) communicates with all the units within her group (all the patrol vehicles on the east side of town, for example). The units within this group comprise what is typically known as a talkgroup. There are some communications which are direct unit-to-unit conversations where one individual converses with another individual. The call is initiated by a radio and is directed to another single radio. Within the system, no one outside of these two users hears the conversation. This call is referred to as I-Call.

Key Beep - This is another term for the tone you hear as a keypad acknowledgement beep. The default setting is on. If you have turned the Key Beep off, you now have a silent keypad. You will not hear a tone each time you press a key.

PC Control - This term is associated with the ability to program frequencies and other useful information via a computer by means of the Uniden national database or third party software. You can change the transfer speed on the scanner needed to be compatible with your PC. (See page 55)

Scan List - When you designate a bank to be a trunking bank, your scanner sets up 10 Scan Lists, which are simply list of your favourite IDs. Each list can contain up to 10 IDs, so you can store a total of 100 IDs for each trunk bank. These lists are designed to help you organise the trunking system users into categories.

Screen mask - Screen Mask reduces the amount of information that appears on the display. Alpha tags that you have set for a channel along with a few function icons will appear only on the display. This mode is particularly useful in public safety vehicles where that are already overloaded with information. Screen Mask does not work in Search mode.

Status Bit - This term refers to Motorola Type II systems. There is a method by which special types of communications utilise unique talk group numbers. For example, if all emergency calls are set to occur on a specific talk group number then you will not miss the transmission even if you have not programmed all the talk group numbers. With the Status Bit on and you have programmed the unique number, then you don't have to worry what the rest of the groups numbers are. The topic of interest will be picked up.

Talkgroup - A group of users within a trunked system that communicate with one another.

Appendix

Preset Fleet Maps

Preset Map 1

Block	Size Code
0	S11
1	S11
2	S11
3	S11
4	S11
5	S11
6	S11
7	S11

Preset Map 2

Block	Size Code
0	S4
1	S4
2	S4
3	S4
4	S4
5	S4
6	S4
7	S4

Preset Map 3

Block	Size Code
0	S4
1	S4
2	S4
3	S4
4	S4
5	S4
6	S12
7	--

Preset Map 4

Block	Size Code
0	S12
1	--
2	S4
3	S4
4	S4
5	S4
6	S4
7	S4

Preset Map 5

Block	Size Code
0	S4
1	S4
2	S12
3	--
4	S4
5	S4
6	S4
7	S4

Preset Map 6

Block	Size Code
0	S3
1	S10
2	S4
3	S4
4	S12
5	--
6	S12
7	--

Preset Map 7

Block	Size Code
0	S10
1	S10
2	S11
3	S4
4	S4
5	S4
6	S4
7	S4

Preset Map 8

Block	Size Code
0	S1
1	S1
2	S2
3	S2
4	S3
5	S3
6	S4
7	S4

Preset Map 9

Block	Size Code
0	S4
1	S4
2	S0
3	S0
4	S0
5	S0
6	S0
7	S0

Preset Map 10

Block	Size Code
0	S0
1	S0
2	S0
3	S0
4	S0
5	S0
6	S4
7	S4

Preset Map 11

Block	Size Code
0	S4
1	S0
2	S0
3	S0
4	S0
5	S0
6	S0
7	S0

Preset Map 12

Block	Size Code
0	S0
1	S0
2	S0
3	S0
4	S0
5	S0
6	S0
7	S4

Preset Map 13

Block	Size Code
0	S3
1	S3
2	S11
3	S4
4	S4
5	S0
6	S0
7	S0

Preset Map 14

Block	Size Code
0	S4
1	S3
2	S10
3	S4
4	S4
5	S4
6	S12
7	--

Preset Map 15

Block	Size Code
0	S4
1	S4
2	S4
3	S11
4	S11
5	S0
6	S12
7	--

Preset Map 16

Block	Size Code
0	S3
1	S10
2	S10
3	S11
4	S0
5	S0
6	S12
7	--

User Defined Fleet Maps

Type I Programming Information

When a Type I system is designed, the address information for all the IDs is divided into 8 equal sized blocks, numbered 07. When you program your scanner to track a Type I system, you must select a size code for each of these blocks. When you have assigned a size code to all 8 blocks, you'll have defined the Fleet Map for the system you're tracking. Each size code determines the number of Fleets, Subfleets, and IDs each block will have. For example, a size code of "4" has one Fleet, which is divided into 16 separate Subfleets, and it has a total of 512 individual IDs.

When a block is assigned a size code, the Fleet or Fleets created within the block are assigned a Type I ID. The way these IDs display on your scanner depend on the block number and the blocks size code. When a Type I ID displays, the left most digit represents the block which contains the ID. The next two or three digits identify which Fleet is active, and the last digit(s) identifies the Subfleet.

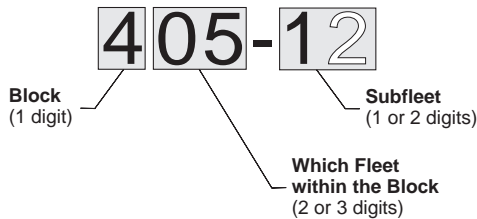

The details concerning how the size codes are selected by a Type I System designer are highly dependent on the specific needs of the systems users. Some organisations may want many subfleets with only a few radios each, while another organisation may want only a few subfleets with many radios each. Your task is to program your fleet map with the same size code assignments as the trunked system. If you do this accurately, you'll track all the Fleet-Subfleet combinations used by the system. In other words, you'll hear complete communications while monitoring a trunked system.

If you don't already know the size codes used, you'll have to guess at them. But since you don't have to figure out all the blocks at once, this isn't as hard as it seems. Select a size code for a block, and then press **SCAN**. Now listen to the communications. If you decide you are receiving most of the replies to the conversations with IDs assigned to the block you just programmed, then you've probably selected the right size code and can work on the next block of the map.

Finally, for most public safety systems there are some size codes which are more common. SIZE CODE 3 and SIZE CODE 4 are probably the most common, followed by SIZE CODE 10, SIZE CODE 11, and SIZE CODE 12.

Fleet Map Size Codes

Size	Fleets	Subfleets	IDs	Blocks Used
0	Reserves block for Type II IDs			+
1	128	4	16	1
2	16	8	64	1
3	8	8	128	1
4	1	16	512	1
5	64	4	32	1
6	32	8	32	1
7	32	4	64	1
8	16	4	128	1
9	8	4	256	1
10	4	8	256	1
11	2	16	256	1
12	1	16	1024	2
13	1	16	2048	4
14	1	16	4096	8

Size Code Restrictions

If you select size code 12, 13, or 14, there are some restrictions as to which blocks can be used for these codes.

- SIZE CODE 12 can only be assigned to Blocks 0, 2, 4, or 6.
- SIZE CODE 13 can only be assigned to Blocks 0 and 4.
- SIZE CODE 14 can only be assigned to Block 0.

Since these size codes require multiple blocks, you will be prompted for the next available block when programming a Fleet Map. For example, if you assign Block 0 as an SIZE CODE 12, you will be prompted for Block 2, the next block available, instead of Block 1. And if you assign Block 0 as an SIZE CODE 14, you would not see another prompt because it uses all available blocks.

AUSTRALIAN REVERSE FREQUENCY LIST

Lower	Upper	Band Name	Mode	Reverse	Designation
31.0000	32.0000	VHF Low band	FM	plus 2 MHz	Repeater outputs
33.0000	34.0000	VHF Low band	FM		Repeater inputs
35.0000	36.0000	VHF Low band	FM	plus 2 MHz	Repeater outputs
37.0000	38.0000	VHF Low band	FM		Repeater inputs
44.0000	45.0000	VHF Low band	FM	minus 2 MHz	Repeater outputs
42.0000	43.0000	VHF Low band	FM		Repeater inputs
53.5000	53.9750	6 metre ham band	MULTI	minus 1 MHz	Repeater outputs
52.5000	52.9750	6 metre ham band	MULTI		Repeater inputs
70.2500	72.3000	VHF Mid band (E)	FM	plus 2.5 MHz	Repeater outputs
72.7500	74.8000	VHF Mid band (E)	FM		Repeater inputs
77.5000	79.8125	VHF Mid band (E)	FM	plus 2.5 MHz	Repeater outputs
80.0000	82.3125	VHF Mid band (E)	FM		Repeater inputs
85.0000	87.2000	VHF Mid band (E)	FM	minus 2.5 MHz	Repeater outputs
82.5000	84.7000	VHF Mid band (E)	FM		Repeater inputs
146.6250	147.0000	2 metre ham band	MULTI	minus 600 kHz	Repeater outputs
146.0250	146.4000	2 metre ham band	MULTI		Repeater inputs
147.0250	147.3500	2 metre ham band	MULTI	plus 600 kHz	Repeater outputs
147.6250	147.9500	2 metre ham band	MULTI		Repeater inputs
149.2500	149.7625	VHF High band (A)	FM	plus 4.6 MHz	Repeater outputs
153.8500	154.3625	VHF High band (A)	FM		Repeater inputs
150.0000	151.4000	VHF High band (A)	FM	plus 4.6 MHz	Repeater outputs
154.6000	156.0000	VHF High band (A)	FM		Repeater inputs
162.0500	165.2000	VHF High band (A)	FM	minus 4.6 MHz	Repeater outputs
157.4500	160.6000	VHF High band (A)	FM		Repeater inputs
165.2000	168.2000	VHF High band (A)	FM	plus 4.6 MHz	Trunked repeater outputs
169.8000	172.8000	VHF High band (A)	FM		Trunked repeater inputs
412.4500	419.9875	UHF low band (T)	FM	minus 9.45 MHz	Repeater outputs
403.0000	410.5375	UHF low band (T)	FM		Repeater inputs
438.0250	439.9750	70 cm ham band	MULTI	minus 5 MHz	Repeater outputs
433.0250	434.9750	70 cm ham band	MULTI		Repeater inputs
460.0000	469.4500	UHF mid band (U)	FM	minus 9.5 MHz	Repeater outputs
450.5000	459.9500	UHF mid band (U)	FM		Repeater inputs
470.0000	471.2000	UHF mid band (W)	FM	plus 5.2 MHz	Repeater outputs
475.2000	476.4000	UHF mid band (W)	FM		Repeater inputs
472.2500	474.7750	UHF mid band (W)	FM	plus 5.2 MHz	Repeater outputs
477.4500	479.9750	UHF mid band (W)	FM		Repeater inputs
485.2000	489.9875	UHF mid band (W)	FM	minus 5.2 MHz	Repeater outputs
480.0000	484.7875	UHF mid band (W)	FM		Repeater inputs
490.0000	494.7750	UHF high band (W)	FM	plus 5.2 MHz	Repeater outputs
495.2000	499.9750	UHF high band (W)	FM		Repeater inputs
500.0000	509.5250	UHF high band (W1)	FM	plus 10 MHz	Repeater outputs
510.0000	519.5250	UHF high band (W1)	FM		Repeater inputs
865.0000	870.0000	800 MHz band	FM	minus 45 MHz	Trunked repeater outputs
820.0000	825.0000	800 MHz band	FM		Trunked repeater inputs

CTCSS Frequency List (Hz)

67.0	71.9	74.4	77.0	79.7	82.5	85.4	88.5	91.5	94.8
97.4	100.0	103.5	107.2	110.9	114.8	118.8	123.0	127.3	131.8
136.5	141.3	146.2	151.4	156.7	162.2	167.9	173.8	179.9	186.2
192.8	203.5	210.7	218.1	225.7	233.6	241.8	250.3		

DCS Tone Code

023	025	026	031	032	036	043	047	051	053
054	065	071	072	073	074	114	115	116	122
125	131	132	134	143	145	152	155	156	162
165	172	174	205	212	223	225	226	243	244
245	246	251	252	255	261	263	265	266	271
274	306	311	315	325	331	332	343	346	351
356	364	365	371	411	412	413	423	431	432
445	446	452	454	455	462	464	465	466	503
506	516	523	526	532	546	565	606	612	624
627	631	632	654	662	664	703	712	723	731
732	734	743	754						

Memo

Memo

Memo

UBC780XLT SHORTCUTS

To automatically store frequencies while searching, turn on "Auto Store" after setting up search range.

Press **MENU** + **4** + **6** + **1**.
Then enter the bank number and press **SCH**.

To set up a system for trunk tracking, choose a bank, then enter system type. (for example; bank number 6).

Press **MENU** + **3** + **6** + **1**.

Then enter the system you want to track.
Press **E**.

To search a specific range of frequencies, set up the "Edit Range" of a specific bank.

(for example; bank number 10)

Press **MENU** + **4** + **1** + **0**
+ **1**. Then enter the lower and upper ranges and press **SCH**.

To change the alpha tag on the specific range of frequencies that you set, do the following:

(for example; bank number 10)

Press **MENU** + **4** + **1** + **0**
+ **4**. Using the VFO control, enter the tag and then press **E**.

To record the specific range of frequencies that you set, turn on the LINE output.

Press **MENU** + **4** + **5** + **1**.

The **LINE** icon appears.

To change the alpha tag on a specific channel, do the following:

(for example; channel number 5).

Press **MENU** + **2** + **5** + **E**
+ **1**. Using the VFO control, enter the tag and then press **E**.

To attenuate a specific channel that you set, do the following:

(for example; channel number 5)

Press **MENU** + **2** + **5** + **E**
+ **5** + **1**.

The **ATT** icon appears.

To record a specific channel that you set, turn on the LINE output.

(for example; channel number 5)

Press **MENU** + **2** + **5** + **E**
+ **8** + **1**.

The **LINE** icon appears.

If you need any assistance with this product, please check out our website at www.uniden.com.au and www.uniden.co.nz. A Uniden representative will be happy to help you with any matters regarding the operation of this unit, available accessories, or any other related matters.

UBC780XLT Flow Charts

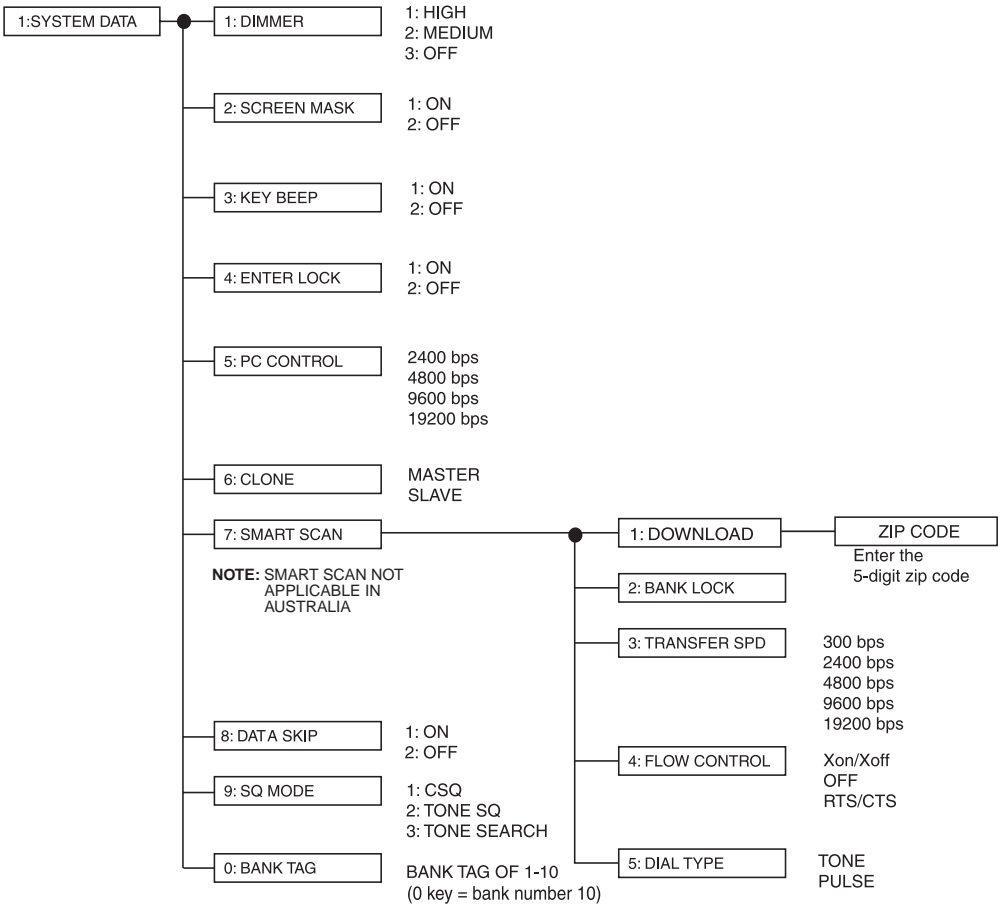

2: CHANNEL DATA

CH NO.

Enter the channel number (1-500)

1: ALPHA TAG

Program using VFO

2: DELAY

- 1: NONE
- 2: 1 SECOND
- 3: 2 SECONDS
- 4: 4 SECONDS
- 5: INFINITE
- 6: -2 SECONDS
- 7: -5 SECONDS
- 8: -10 SECONDS

3: TONE DATA

- 1: CTCSS
- 2: DCS
- 3: OFF (with TONE LOCK)

4: BEEP ALERT

- 1: ON
- 2: OFF

5: ATTENUATOR

- 1: ON
- 2: OFF

6: STEPS

- 1: 5 KHz
- 2: 7.5 KHz
- 3: 10 KHz
- 4: 12.5 KHz
- 5: 25 KHz
- 6: 50 KHz
- 7: 100 KHz
- 8: AUTO

7: MODE

- 1: AM
- 2: FM
- 3: WFM
- 4: NFM

8: RECORD

- 1: ON
- 2: OFF

UBC780XLT Flow Charts (continued)

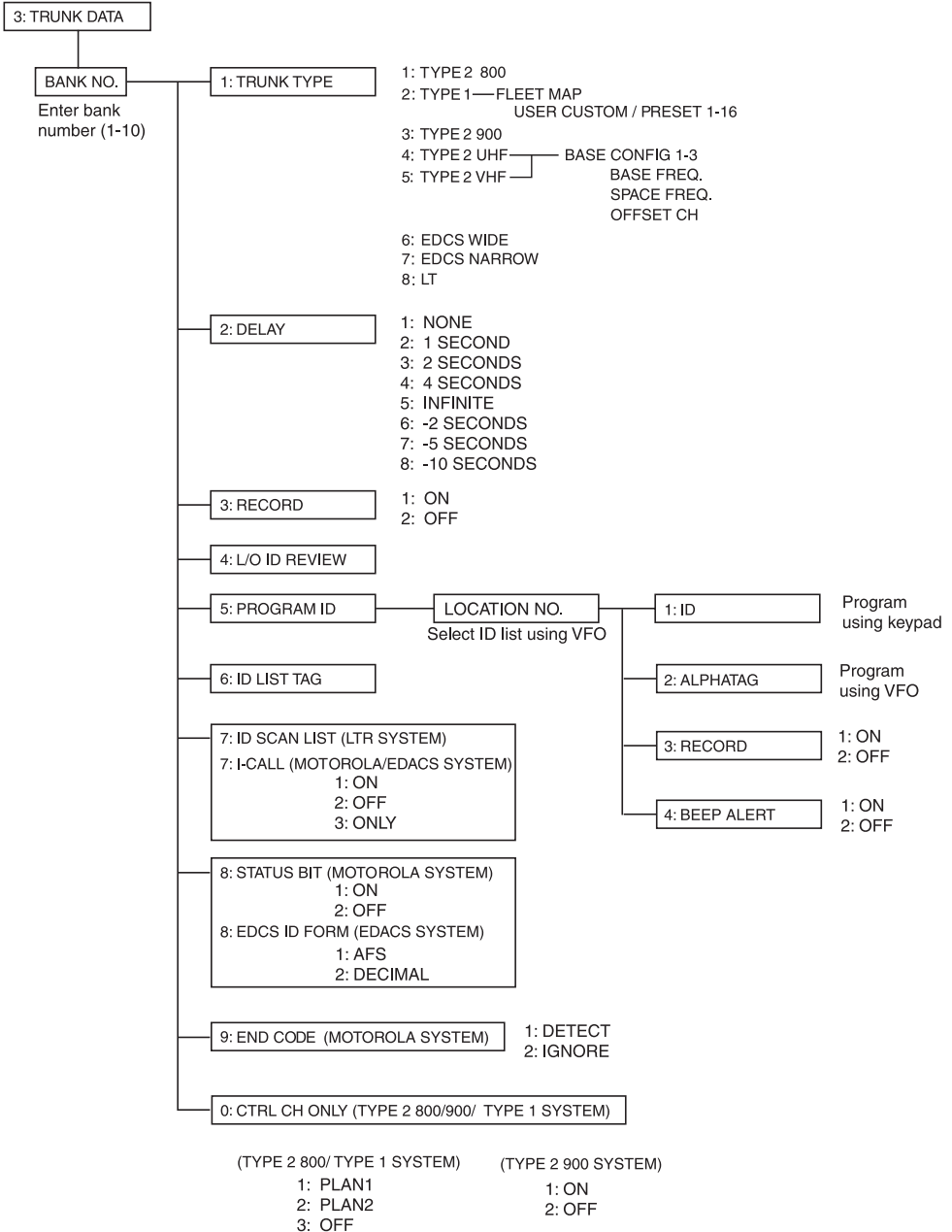

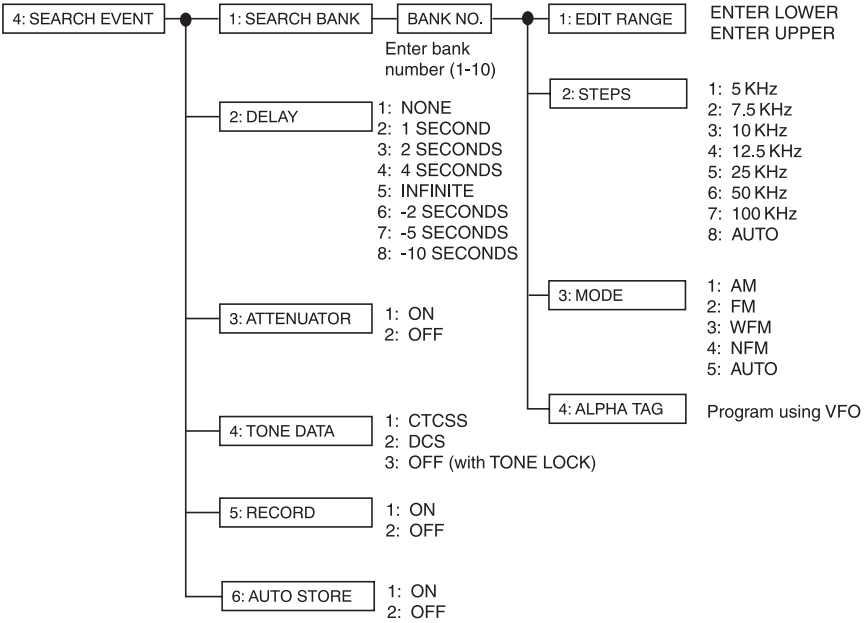

UBC780XLT SHORTCUTS

To reduce the amount of information that is shown on the display, set up "Screen Mask".

Press **MENU** + **1** + **2** + **1**.

Restore by pressing **VFO** control.

To silence the keypad from sounding acknowledgement tones after each press, turn off the "Key Beep".

Press **MENU** + **1** + **3** + **2**.

To increase the backlight of the display, set "Dimmer" to HIGH.

Press **MENU** + **1** + **1** + **1**.

To turn off the backlight of the display, set "Dimmer" to OFF.

Press **MENU** + **1** + **1** + **3**.

To prevent accidental reprogramming of frequencies or talkgroups, lock out the keypad.

Press **MENU** + **1** + **4** + **1**.

To silence the scanner's audio output, set the scanner to "Mute On".

Press and hold **SELECT**
MUTE.

To replace frequencies on a channel that had been already set;

(for example; replace the frequency on channel 5 to 155.000)

Press **MAN** + **5** + **MAN** + **1** + **5** + **5** + **.** + **E**.

To assign an alphanumeric text tag to a bank, choose the bank number;

(for example; bank number 1)

Press **MENU** + **1** + **0** + **1** then using VFO control, enter the text. After the text is entered, press **SELECT**.

To receive an alert for activity on specific channel, turn on "Beep Alert" for that channel.

Press **MENU** + **2** + select channel + **E** + **4** + **1**.

To receive an alert for activity on specific IDs while trunk tracking, turn on "Beep Alert" for that ID.

Press **MENU** + **3** + select bank + **5** + select ID list + **E** + **4** + **1**.

This shortcut card is designed to assist you in getting through the menu screens using the direct entry mode for commonly used features. Please read the manual thoroughly before using this card. Be sure to back out of the menu screen after each shortcut by repeatedly pressing MENU.

One Year Limited Warranty

Important: Evidence of original purchase is required for warranty service.

Warrantor: Uniden Australia Pty Limited ACN 001 865 498
Uniden New Zealand Limited

ELEMENT OF WARRANTY: Uniden warrants to the original retail owner for the duration of this warranty, its UBC780XLT (herein after referred to as the Product), to be free from defects in materials and craftsmanship with only the limitations or exclusions set out below.

WARRANTY DURATION: This warranty to the original retail owner only, shall terminate and be of no further effect 12 months after the date of original retail sale. This warranty will be deemed invalid if the product is; (A) Damaged or not maintained as reasonable and necessary, (B) Modified, altered or used as part of any conversion kits, subassemblies, or any configurations not sold by Uniden, (C) Improperly installed, (D) Repaired by someone other than an authorised Uniden Repair Agent for a defect or malfunction covered by this warranty, (E) Used in conjunction with any equipment or parts or as part of a system not manufactured by Uniden.

PARTS COVERED: This warranty covers for one (1) year, the Base Unit. All accessories, AC Adaptor, Cigarette Lighter Adaptor Cord, Antenna & Mounting Bracket are covered for 90 days only.

STATEMENT OF REMEDY: In the event that the product does not conform to this warranty at any time while this warranty is in effect, the warrantor at its discretion, will repair the defect or replace the product and return it to you without charge for parts or service. THIS WARRANTY DOES NOT COVER OR PROVIDE FOR THE REIMBURSEMENT OR PAYMENT OF INCIDENTAL OR CONSEQUENTIAL DAMAGES. THIS GUARANTEE IS IN ADDITION TO AND DOES NOT IN ANY WAY AFFECT YOUR RIGHTS UNDER THE CONSUMER GUARANTEE ACT.

WARRANTY CARD: If a warranty card has been included with this product then please fill it in and return to us within 14 days of purchase. Your name and the Serial number of the product will then be registered in our database and this will help us process your claim with greater speed and efficiency should you require warranty service.

PROCEDURE FOR OBTAINING PERFORMANCE OR WARRANTY: In the event that the product does not conform to this warranty, the Product should be shipped or delivered, freight pre-paid, with evidence of original purchase (eg. a copy of the sales docket), to the warrantor at:

UNIDEN AUSTRALIA PTY LIMITED
SERVICE DIVISION
345 Princes Highway,
Rockdale NSW 2216
www.uniden.com.au

UNIDEN NEW ZEALAND LIMITED
SERVICE DIVISION
150 Harris Road,
East Tamaki, Auckland
www.uniden.co.nz

Customers in other States should ship or deliver the Product freight pre-paid to their nearest Uniden Authorised Repair Centre (Contact Uniden for the nearest Warranty Agent to you).

Uniden®

Beancat®

© 2001 Uniden Australia Pty. Ltd.
Uniden New Zealand Ltd.

All rights reserved.
Printed in the Philippines.

UBZZ01305AZ